

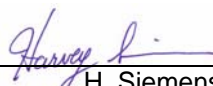

Eagle Copters Ltd.
823 McTavish Road NE
Calgary, Alberta, Canada
T2E 7G9
Tel: 1 403 250 7370
Fax: 1 403 250 7110
<http://www.eaglecopters.com>



MANUFACTURER'S DATA MANUAL
MD-D212-725-1
Eagle Single

Prepared By: 
H. Siemens
Eagle Copters

Reviewed By: 
D. Shepherd
DE #02

• COPYRIGHT © 2007 BY DART AEROSPACE LTD •

This document is private and confidential and is supplied on the express condition that it is not to be used for any purpose or copied or communicated to any other person without written permission from Dart Aerospace Ltd.

Unapproved

Revision: **D**
Date: 10.05.12



Log of Revisions

Revision A2007-06-01 Revision D 2010-05-12
 Revision B2007-11-30 Revision E.....
 Revision C2008-11-26 Revision F.....

List of Effective Pages

Page	Amendment	Page	Amendment	Page	Amendment
Intro-1	D	1-22	D	2-7	A
Intro-2	D	1-23	D	2-8	A
Intro-3	D	1-24	D	2-9	A
Intro-4	B	1-25	D	2-10	A
		1-26	D	2-11	A
1-1	D	1-27	D	2-12	A
1-2	D	1-28	D	2-13	A
1-3	D	1-29	D	2-14	A
1-4	D	1-30	D	2-15	A
1-5	D	1-31	D	2-16	A
1-6	D	1-32	D		
1-7	D	1-33	D	3-1	A
1-8	D	1-34	D	3-2	A
1-9	D	1-35	D	3-3	A
1-10	D	1-36	D	3-4	A
1-11	D	1-37	D	3-5	A
1-12	D	1-38	D	3-6	A
1-13	D	1-39	D	3-7	A
1-14	D	1-40	D	3-8	A
1-15	D			3-9	A
1-16	D	2-1	A	3-10	A
1-17	D	2-2	A	3-11	A
1-18	D	2-3	A	3-12	A
1-19	D	2-4	A	3-13	A
1-20	D	2-5	A		
1-21	D	2-6	A		

• COPYRIGHT © 2007 BY DART AEROSPACE LTD •
 This document is private and confidential and is supplied on the express condition that it is not to be used for any purpose or copied or communicated to any other person without written permission from Dart Aerospace Ltd.

Unapproved

Revision: **D**
 Date: 10.05.12



Revisions

Revised text is indicated by a black vertical line. Insert latest revision pages;
dispose of superseded pages.

• COPYRIGHT © 2007 BY DART AEROSPACE LTD •

This document is private and confidential and is supplied on the express condition that it is not to be used for any purpose or copied or communicated to any other person without written permission from Dart Aerospace Ltd.

Unapproved

Revision: **D**
Date: 10.05.12



General Information

This manual is a manufacturer's data manual (MD) for the basic Bell 212 Manufacturer's Data Manual. However, all relevant information from the basic Bell 212 Manufacturer's Data Manual has been incorporated into this MD for the convenience of the pilot. Therefore, there is no need to refer to the basic Bell 212 Manufacturer's Data Manual.

To indicate which sections are original from the Bell 212 Flight Manual and which sections are specific to this Flight Manual Supplement the following indication have been used.

If the section or paragraph is from the Bell 212 Manufacturer's Data it has an ivory background.

If the section or paragraph is part of the amended information that forms the Manufacturer's Data, it has no special formatting.

This MD is applicable when the aircraft has been modified with the installation of a Honeywell T5317A/B/BCV engine as per Canadian STC SH07-28.

This manual is divided into three sections as follows:

- Section 1 Systems Description
- Section 2 Handling and Servicing
- Section 3 Conversion Charts and Tables

This MD Manual (MD-D212-725-1) consists of additional information to be used in conjunction with the flight manual. This manual contains useful information to familiarize the operator with the helicopter and its systems, to facilitate ground handling and servicing and assist if flight planning and operations.

• COPYRIGHT © 2007 BY DART AEROSPACE LTD •

This document is private and confidential and is supplied on the express condition that it is not to be used for any purpose or copied or communicated to any other person without written permission from Dart Aerospace Ltd.

Unapproved

Revision: **B**
Date: 07.11.30

Section 1

Systems Description

Table of Contents

1.1	Introduction	1-3
1.2	Helicopter Description.....	1-3
1.3	Principal Dimensions	1-4
1.4	Location References.....	1-4
1.4.1	Fuselage Stations.....	1-4
1.4.2	Waterlines.....	1-4
1.4.3	Buttock Lines	1-4
1.5	General Arrangement	1-5
1.5.1	Crew Compartment.....	1-5
1.5.2	Passenger/Cargo Compartment.....	1-6
1.5.3	Cargo Compartment	1-7
1.6	Rotor Systems	1-8
1.6.1	Main Rotor	1-8
1.6.2	Tail Rotor	1-8
1.6.3	Rotor System Indicators	1-9
1.7	Transmission	1-10
1.7.1	Transmission Oil System.....	1-10
1.7.2	Transmission Indicators.....	1-10
1.8	Power Plant	1-12
1.8.1	Engine Controls	1-12
1.8.2	Engine Indicators	1-13
1.9	Fuel System	1-20
1.9.1	Fuel System Controls	1-20
1.9.2	Fuel System Indicators	1-21
1.10	Electrical Systems	1-23
1.10.1	DC Electrical System.....	1-23
1.10.2	AC Electrical System.....	1-23
1.10.3	Electrical System Controls.....	1-24
1.10.4	Electrical System Indicators.....	1-25

• COPYRIGHT © 2007 BY DART AEROSPACE LTD •

This document is private and confidential and is supplied on the express condition that it is not to be used for any purpose or copied or communicated to any other person without written permission from Dart Aerospace Ltd.

Revision: **D**

Date: 10.05.12

Unapproved

1.11	Hydraulic Systems.....	1-26
1.11.1	Hydraulic System Controls.....	1-26
1.11.2	Hydraulic System Indicators.....	1-26
1.12	Flight Control System.....	1-28
1.12.1	Force Trim System.....	1-28
1.12.2	Force Trim Controls.....	1-29
1.13	Pitot-Static System.....	1-30
1.14	Heating System.....	1-30
1.15	Ventilating System.....	1-30
1.16	Lighting Systems.....	1-31
1.16.1	Interior Lighting.....	1-31
1.16.2	Exterior Lighting.....	1-31
1.17	Windshield Wipers.....	1-32
1.18	Rotor Brake System (If installed).....	1-32
1.19	Emergency Equipment.....	1-33
1.19.1	Fire Detection.....	1-33
1.19.2	Engine Fire Extinguishing System.....	1-33
1.19.3	Portable Fire Extinguishers.....	1-34
1.19.4	First Aid Kit.....	1-34
1.19.5	Emergency Exit – Door Jettison.....	1-34
1.19.6	Emergency Exit – Window Jettison.....	1-34
1.19.7	Jettison Panels.....	1-34

List of Figures

Figure 1-1	– Principal Exterior Dimensions.....	1-35
Figure 1-2	– Principal Interior Dimensions.....	1-36
Figure 1-3	– Fuel System (Sheet 1 of 2).....	1-37
Figure 1-3	– Fuel System (Sheet 2 of 2).....	1-38
Figure 1-4	– Electrical System Schematic.....	1-39
Figure 1-5	– Master Caution/Warning Panel – Typical.....	1-40

• COPYRIGHT © 2007 BY DART AEROSPACE LTD •

This document is private and confidential and is supplied on the express condition that it is not to be used for any purpose or copied or communicated to any other person without written permission from Dart Aerospace Ltd.

Revision: **D**

Date: 10.05.12

Unapproved

Section 1

Systems Description

1.1 Introduction

The Eagle Single helicopter, primary and auxiliary systems, and emergency equipment are described in this section. Optional equipment systems which do not require flight manual supplements (FMS) will be described herein as data becomes available.

1.2 Helicopter Description

The Eagle Single is a single engine conversion of the Bell 212. It is a single pilot, nine passenger single engine helicopter with a two-blade semi-rigid main rotor and a two bladed tail rotor that provides directional control.

Airframe is a semi-monocoque structure with metal and fiberglass covering. Two longitudinal main beams and pylon support structure provide primary support.

Skid type landing is affixed below fuselage. Optional airframe mounted emergency pop out flotation gear is available.

Figure 1-1 shows the principal exterior dimensions of the helicopter.
Figure 1-2 shows the principal interior dimensions of the helicopter.
Figure 1-3 shows the fuel system schematic for the helicopter.
Figure 1-4 shows the electrical schematic of the helicopter.
Figure 1-5 shows the master caution panel for the helicopter.

• COPYRIGHT © 2007 BY DART AEROSPACE LTD •

This document is private and confidential and is supplied on the express condition that it is not to be used for any purpose or copied or communicated to any other person without written permission from Dart Aerospace Ltd.

Unapproved

Revision: **D**

Date: 10.05.12

1.3 Principal Dimensions

Principal exterior dimensions are shown in Figure 1-1. All height dimensions must be considered approximate due to variations in loading and landing gear deflection

Principal interior dimensions, to include cargo compartment, are shown in Figure 1-2.

1.4 Location References

Locations on and within helicopter can be determined in relation to fuselage stations, waterlines, and buttock lines measured in inches from known reference points.

1.4.1 Fuselage Stations

Fuselage stations (FS or STA) are vertical planes perpendicular to, and measured along, longitudinal axis of helicopter. Station zero is reference datum plane and is 20.0 inches (508 millimeters) aft of most forward point on cabin nose.

1.4.2 Waterlines

Waterlines (WL) are horizontal planes perpendicular to, and measured along, vertical axis of helicopter. Waterline zero is a reference plane located 7.44 inches (189 millimeters) below lowest point on fuselage.

1.4.3 Buttock Lines

Buttock lines (BL) are vertical planes perpendicular to, and measured to left and right along, lateral axis of helicopter. Buttock line zero is a plane at longitudinal centerline of helicopter.

• COPYRIGHT © 2007 BY DART AEROSPACE LTD •

This document is private and confidential and is supplied on the express condition that it is not to be used for any purpose or copied or communicated to any other person without written permission from Dart Aerospace Ltd.

Revision: **D**

Date: 10.05.12

Unapproved

1.5 General Arrangement

Fuselage forward section contains nose compartment for electrical and avionics equipment, crew compartment, and passenger/cargo compartment. Center section incorporates transmission compartment and pylon support structure. Aft section houses the engine and oil coolers, and has compartments for avionics, bleed air heater, and optional equipment components.

Tailboom is attached to aft end of fuselage and supports tail rotor and drive train, vertical fin, horizontal stabilizer/elevator, and tail skid. A cargo compartment is located in forward end of tailboom.

1.5.1 Crew Compartment

Crew compartment or cockpit occupies forward part of cabin. Pilot station is on right side and copilot/forward passenger station is on left.

A door on either side permits direct access to crew compartment. Glass windshields and clear acrylic windows in crew doors, roof, and lower nose area allow good visibility from crew compartment.

1.5.1.1 Crew Seats

Pilot and copilot seats are equipped with shoulder harnesses with inertia reels. Adjustment handles, located beneath right side of each seat, can be pulled to adjust seats 4.0 inches (10.2 centimeters) vertically and 4.5 inches (11.4 centimeters) longitudinally.

1.5.1.2 Crew Seat Restraint System

Each crew seat is equipped with lap seatbelt and a dual shoulder harness with inertia reel which locks in event of rapid deceleration.

1.5.1.3 Instrument Panel

The instrument panel extends across front of cockpit and is tilted slightly to

• COPYRIGHT © 2007 BY DART AEROSPACE LTD •

This document is private and confidential and is supplied on the express condition that it is not to be used for any purpose or copied or communicated to any other person without written permission from Dart Aerospace Ltd.

Revision: **D**

Date: 10.05.12

Unapproved

provide better viewing of instruments by flight crew. Pilot flight and navigational instruments are on right; propulsion, fuel, hydraulic, and electrical systems instruments are in center; and optional copilot flight and navigational instruments are on left. All instruments have integral or post white lighting. Warning and caution lights are sunlight readable.

1.5.1.4 Overhead Console

Overhead console is centered on cabin ceiling and contains electrical system switches and circuit breakers.

Three types of switches are used in overhead console:

Rheostat.

Four position rotary.

Positive latch.

Console has integral white lighting controlled by CONSOLE LT switch.

1.5.1.5 Pedestal

Pedestal is located between crew seats and supports avionics control panels and engine and flight control system switches.

1.5.2 Passenger/Cargo Compartment

Aft area of cabin contains a space of 220 cubic feet (6.2 cubic meters) for carrying passengers or internal cargo.

A sliding door and hinged panel on each side of cabin provides full, direct access to passenger/cargo compartment. Acrylic windows in doors allow outside viewing from any seat.

1.5.2.1 Passenger Seats

Passenger seats are arranged in a row of four seats facing aft, another row of five seats facing forward, and a pair of seats facing outboard from each side of pylon support structure. All seats are equipped with lap seatbelts.

• COPYRIGHT © 2007 BY DART AEROSPACE LTD •

This document is private and confidential and is supplied on the express condition that it is not to be used for any purpose or copied or communicated to any other person without written permission from Dart Aerospace Ltd.

Revision: **D**

Date: 10.05.12

Unapproved

1.5.2.2 Tie Downs and Equipment Fittings

Tiedown rings and studs are recessed into cabin deck for securing internal cargo, passenger seats, and other optional equipment kits such as internal hoist, litters, etc. Additional studs are incorporated into cabin roof for attachment of optional equipment kits.

Deck mounted tiedown fittings have airframe structural capacity of 1250 pounds (567 kilograms) vertical and 500 pounds (227 kilograms) horizontal per fitting.

Provisions for installation of cargo tiedown fittings are incorporated in aft cabin bulkhead and transmission support structure. Each tiedown point has an airframe structural capacity of 1250 pounds (567 kilograms) at 90 degrees to bulkhead and 500 pounds (227 kilograms) in any direction parallel to bulkhead.

1.5.3 Cargo Compartment

Cargo compartment is located in forward end of tailboom and has a capacity of 28 cubic feet (0.8 cubic meters). Compartment can carry up to 400 pounds (181 kilograms) of baggage or other cargo, which can be secured using tiedown fittings provided.

Access door is on right side of tailboom and is provided with a key lock for security of compartment contents.

Two interior lights illuminate when door is open. CARGO DOOR LOCK caution light, on caution panel, illuminates when door is open or is not properly latched.

A smoke detector is installed in compartment and is connected to CARGO FIRE warning light located on instrument panel.

• COPYRIGHT © 2007 BY DART AEROSPACE LTD •

This document is private and confidential and is supplied on the express condition that it is not to be used for any purpose or copied or communicated to any other person without written permission from Dart Aerospace Ltd.

Revision: **D**

Date: 10.05.12

Unapproved

1.6 Rotor Systems

1.6.1 Main Rotor

Main rotor is 48 feet in diameter and is a two bladed, semi-rigid flapping type, employing pre-coning and under-slinging. Rotor head assembly consists of two all metal bonded blades, yoke and spindle assembly, trunnion assembly, tension-torsion straps, pitch change horns, blade grips, and drag braces. Each blade is connected to a common yoke by a blade grip and pitch change bearings with tension straps to carry centrifugal forces.

Main rotor assembly is attached to mast with a bearing mounted trunnion, allowing rotor to flap. Trunnion is secured to mast by splines and nut cap fitting that incorporates provisions for cable attachment used in hoisting helicopter. Blade pitch change is accomplished by movement of collective and a series of controls terminating at blade grip horn. Upward movement of collective increases angle of attack of rotor blades and causes helicopter to ascend. Downward movement of collective decreases angle of attack of rotor blades allowing helicopter to descend. Tilting of rotor is accomplished by movement of cyclic, resulting in a corresponding change in plane of rotation of rotor.

1.6.2 Tail Rotor

Tail rotor is a two bladed system mounted on right side of vertical fin. It is a rigid delta hinged type, employing pre-coning and under-slinging. Each blade is connected to a common yoke by means of a grip and pitch change bearing. Blade and yoke assembly is mounted on tail rotor gearbox shaft by means of a delta hinge trunnion to minimize rotor flapping. Blade pitch is changed by movement of antitorque pedals to control or maintain heading. Blade pitch change provides torque control and change of directional heading.

• COPYRIGHT © 2007 BY DART AEROSPACE LTD •

This document is private and confidential and is supplied on the express condition that it is not to be used for any purpose or copied or communicated to any other person without written permission from Dart Aerospace Ltd.

Revision: **D**

Date: 10.05.12

Unapproved

1.6.3 Rotor System Indicators

Rotor system indicators consist of dual tachometer, rotor RPM caution light, and rotor RPM audio warning signal.

1.6.3.1 Dual Tachometer

The dual tachometer indicates, in percent, main ROTOR RPM (N_R) on inner scale and ENG RPM (N_2) of the engine on outer scale.

1.6.3.2 Rotor rpm caution light

The main rotor RPM caution lights are mounted on the top of the instrument panel. The lights will illuminate to alert pilots that main rotor RPM (N_R) is above or below limits.

1.6.3.3 Rotor rpm audio warning

An audio warning signal will sound in pilot and copilot headsets, simultaneous with illumination of RPM caution light, when main rotor RPM (N_R) decreases below minimum limit.

• COPYRIGHT © 2007 BY DART AEROSPACE LTD •

This document is private and confidential and is supplied on the express condition that it is not to be used for any purpose or copied or communicated to any other person without written permission from Dart Aerospace Ltd.

Unapproved

Revision: **D**

Date: 10.05.12

1.7 Transmission

Transmission is located directly forward of power plant and is supported by isolation mounts attached to fuselage pylon structure. Transmission is connected to and driven by power plant through a main driveshaft. Transmission provides a drive angle change and speed reduction. Transmission driven accessories include a rotor tachometer generator, two hydraulic pumps, an oil pump, and rotor brake.

Transmission may have two debris collectors, one under mast bearing and one under planetary gears, to prevent secondary transmission damage. Transmission may also have a triple zone chip detection system, one in each debris collector and one in sump case.

A gage on the instrument panel allows the flight crew to monitor transmission oil temperature and pressure. Caution lights are provided to warn of high oil temperature, low pressure, and metal particles in the oil. Three remote indicators are located on the right side of the pedestal.

1.7.1 Transmission Oil System

An integral lubrication system circulates oil under pressure throughout transmission. A gear driven pump forces oil out of sump, through a filter, and through external lines to cooler. When oil is cooled and returns to transmission, oil passes through another filter before entering a pressure manifold for circulation throughout transmission. During startups, cooler is bypassed until oil is warm. A pressure relief valve is included in system. Oil level sight gages are located on sump case.

1.7.2 Transmission Indicators

Transmission indicators include an oil temperature and pressure gage, oil temperature and pressure warning lights, and chip detector caution light.

1.7.2.1 Transmission Oil Temperature and Pressure Gage

• COPYRIGHT © 2007 BY DART AEROSPACE LTD •

This document is private and confidential and is supplied on the express condition that it is not to be used for any purpose or copied or communicated to any other person without written permission from Dart Aerospace Ltd.

Unapproved

Revision: **D**

Date: 10.05.12

Transmission oil temperature and pressure gage is a dual instrument that simultaneously displays oil temperature in degrees Celsius on left scale and oil pressure in PSI on right scale.

1.7.2.2 Transmission Oil Warning Lights

XMSN OIL TEMP warning light will illuminate when transmission oil temperature exceeds 110°C and XMSN OIL PRESS warning light will illuminate when transmission oil pressure falls below 30 psi.

1.7.2.3 Transmission Oil Chip Detector Caution Light

XMSN CHIP caution light will illuminate if any of three transmission chip detectors sense metal particles in transmission oil.

• COPYRIGHT © 2007 BY DART AEROSPACE LTD •

This document is private and confidential and is supplied on the express condition that it is not to be used for any purpose or copied or communicated to any other person without written permission from Dart Aerospace Ltd.

Unapproved

Revision: **D**

Date: 10.05.12

1.8 Power Plant

The power plant is a Honeywell T53-17A or T53-17B or T53-17BCV which consists of a free turbine power section that connects directly to the transmission through a free-wheeling unit. The engine has a lubrication system, starter-generator, and fuel control.

1.8.1 Engine Controls

Engine controls include gas producer control system, droop compensator control system, governor switches and various subsystem control switches.

1.8.1.1 Gas Producer Control System

Gas producer control system provides control of gas producer RPM (N_1) of the engine. Twist grip throttles, located on pilot and copilot collective, are connected to gas producer fuel control (which automatically regulates fuel flow) of the engine.

1.8.1.2 Droop Compensator Control System

Droop compensator control system schedules power turbine governor to maintain N_2 RPM within a specified range. A mechanical connection, into a collective system bellcrank, provides automatic scheduling (droop compensation) when changes in collective occur.

1.8.1.3 Governor Switch

Governor switch, located on pedestal, is a two position switch labeled ENGINE GOV AUTO and MANUAL. When in AUTO, automatic fuel control unit (N_1) is automatically controlled and when in MANUAL, the pilot controls N_1 rpm with the throttle.

1.8.1.4 IDLE STOP REL Switch

IDLE STOP REL switches, located on both collectives, are two position, momentary button switches used to activate idle stop solenoid for the engine. When pressed, idle solenoid is retracted and the throttle can be rolled below idle stop.

• COPYRIGHT © 2007 BY DART AEROSPACE LTD •

This document is private and confidential and is supplied on the express condition that it is not to be used for any purpose or copied or communicated to any other person without written permission from Dart Aerospace Ltd.

Revision: **D**

Date: 10.05.12

Unapproved

1.8.1.5 RPM INCR DECR Switch (N₂)

RPM INCR DECR switches, located on pilot and copilot collectives, are three position, momentary on switches. INCR (increase) DECR (decrease) positions controls an electric linear actuator in droop compensator control linkage and provides adjustment of speed selector lever on the engine power turbine governor.

1.8.2 Engine Indicators

Engine indicators include a torquemeter, dual tachometer, gas producer gage, EGT/MGT gage, oil temperature and pressure gages, engine out warning lights, governor caution light, oil pressure caution light, and chip detector caution light.

1.8.2.1 Torquemeter

For aircraft S/Ns 30687, 30931, 30576, 30817 and 30599, the torquemeter displays, in PSI, torque from the engine. For all aircraft except S/Ns 30687, 30931, 30576, 30817 and 30599, the torquemeter displays, in percent, torque from the engine.

For aircraft where the torquemeter displays percent, on power-up, the digital display plays back the data stored in the non-volatile memory. During this time the instrument pointer continues to show the current engine torque, and the current torque is monitored for exceedances. Each parameter played back is preceded by a label identifying the data type. During play back each display frame is displayed for two seconds with the display briefly blanked between items before stepping to the next frame, except when stated otherwise. The data is played back in the following order:

1. All segments are lit providing a  pattern to verify that all display elements are functioning.
2. The first three digits and then the last three digits of the software version are displayed.



• COPYRIGHT © 2007 BY DART AEROSPACE LTD •

This document is private and confidential and is supplied on the express condition that it is not to be used for any purpose or copied or communicated to any other person without written permission from Dart Aerospace Ltd.

Revision: **D**

Date: 10.05.12

Unapproved

3. The flight operation label  is displayed if no exceedance has occurred since the last time the instrument was reset. Otherwise, the flight Operation Exceedance label  is displayed flashing on and off twice per second for ten seconds.

4. The peak torque for the highest torque event since the last instrument reset is displayed followed by the time in seconds the torque was above the alert torque limit (88%) followed by the time in seconds the torque was above the warning torque limit (100%) specified in Table 1-1. If the torque was not above the torque limit a zero (for zero seconds) is displayed. The maximum time the indicator can record is 1023 seconds.

5. If the indicated torque is greater than the threshold torque specified in Table 1-1, the instrument will exit the playback mode and the digital display will start displaying the indicated torque. If the torque is below this threshold the indicator will play back the following information.

6. The flight Operating Exceedance Count label  is displayed followed by the count.

After the instrument has played back the recorded data, normal operation of the digits begins.

1.8.2.2 Dual Tachometer

The dual tachometer simultaneously displays, in percent, ROTOR RPM (N_R) (inner scale) and ENG RPM (N_2) (outer scale).

1.8.2.3 Gas Producer Gage

Gas producer (GAS PROD) RPM (N_1) gage displays engine gas producer in percent of rated RPM.

On power-up, the digital display plays back the data stored in the non-volatile memory. During this time the instrument pointer shows the current engine RPM. A label identifying the data type precedes each parameter played

• COPYRIGHT © 2007 BY DART AEROSPACE LTD •



This document is private and confidential and is supplied on the express condition that it is not to be used for any purpose or copied or communicated to any other person without written permission from Dart Aerospace Ltd.

Revision: **D**

Date: 10.05.12

Unapproved

back. During play back each display frame is displayed for two seconds before stepping to the next frame, except when stated otherwise. The data is played back in the following order:

1. All segments are lit providing a "188.8" pattern to verify that all display elements are functioning.
2. The first three digits and the last three digits of the software version are displayed.
3. The flight Operation label  is displayed if no exceedance has occurred since the last time the instrument was reset. Otherwise, the flight Operation Exceedance label  is displayed flashing on and off twice per second for ten seconds.
4. the peak RPM in % RPM for the highest peak event since the last instrument reset is displayed followed by the number of seconds the RPM was above the red line during this event. IF the RPM was not over the red line, a zero (for zero seconds) is displayed.
5. If the indicated RPM is greater than 5%, the instrument will exit the playback mode and the digital display will start displaying the indicated RPM. If the RPM is below 5%, the indicator will continue to playback the following information:
6. The flight Operation Exceedance Count label  is displayed followed by the count.

After the instrument has played back the recorded data, normal operation of the digits begins.

1.8.2.4 EGT/MGT Gages

Exhaust Gas Temperature (T53-17A) or Measured Gas Temperature (T53-17B/BCV) are displayed in degrees Celsius.

On power-up, the MGT digital display plays back the data stored in the non-

• COPYRIGHT © 2007 BY DART AEROSPACE LTD •





This document is private and confidential and is supplied on the express condition that it is not to be used for any purpose or copied or communicated to any other person without written permission from Dart Aerospace Ltd.

Revision: **D**

Date: 10.05.12

Unapproved

volatile memory. During this time the instrument pointer continues to show current engine temperature, and the current temperature is monitored for exceedances. Each parameter played back is preceded by a label identifying the data type. During play back each display frame is displayed for two seconds with the display briefly blanked between items before stepping to the next frame, except when stated otherwise. The data is played back in the following order:

1. All segments are lit providing a  pattern to verify that all display elements are functioning.
2. The first three digits, and then the last three digits of the software version are displayed.
3. The engine Start label  is displayed if no start mode exceedance has occurred since the last time the instrument was reset. Otherwise, the engine Start Exceedance label  is displayed flashing on and off twice per second for ten seconds.
4. The peak temperature of the highest engine start temperature event since the last instrument reset is displayed followed by the time in seconds the temperature was above the alert temperature limit (863°C) followed by the time in seconds the temperature was above the warning temperature limit(926°C) specified in Table 1-1. If the temperature was not above the temperature limit a zero (for zero seconds) is displayed. The maximum time that the indicator can display is 1024 seconds. Times above 999 seconds are displayed with a leading zero. For example, 1016 seconds is displayed as "016". If the over temperature event was longer than 1024 seconds the indicator will display "024".
5. The flight Operation label  is displayed if no exceedance has occurred since the last time the instrument was reset. Otherwise the flight Operation Exceedance label  is displayed flashing on and off twice per second for ten seconds.

• COPYRIGHT © 2007 BY DART AEROSPACE LTD •

This document is private and confidential and is supplied on the express condition that it is not to be used for any purpose or copied or communicated to any other person without written permission from Dart Aerospace Ltd.

Revision: **D**

Date: 10.05.12

Unapproved

6. The peak temperature for the highest flight operating temperature event since the last instrument reset is displayed followed by the time in seconds the temperature was above the alert temperature limit (820°C) followed by the time in seconds the temperature was above the warning temperature limit (863°C) specified in Table 1-1. If the temperature was not above the temperature limit a zero (for zero seconds) is displayed. The maximum time that the indicator can display is 1024 seconds. Times above 999 seconds are displayed with a leading zero. For example, 1016 seconds is displayed as "016". If the over temperature event was longer than 1024 seconds the indicator will display "024".

7. If the indicated temperature is greater than the threshold temperature specified in Table 1-1, the instrument will exit the playback mode and the digital display will start displaying the indicated temperature. If the temperature is below this threshold the indicator will play back the following information.

8. the Start Cycle count label **SCC** is displayed followed by the count. If the number of start cycles is greater than 999 the start cycle count label will be shown with the first digit of the number of start cycles. For example, 1956 start cycles is indicated by **SCC** followed by **956**.

9. The engine Start Exceedance Count label **SEC** is displayed followed by the count.

10. The flight Operating Exceedance Count label **OEC** is displayed followed by the count.

After the instrument has played back the recorded data, normal operation of the digits begins.

1.8.2.5 Oil Temperature and Pressure Gages

The engine oil temperature and pressure gage simultaneously displays oil temperature in degrees Celsius on left scale and oil pressure in psi on right scale.

• COPYRIGHT © 2007 BY DART AEROSPACE LTD •

This document is private and confidential and is supplied on the express condition that it is not to be used for any purpose or copied or communicated to any other person without written permission from Dart Aerospace Ltd.

Revision: **D**

Date: 10.05.12

Unapproved

1.8.2.6 Engine RPM Warning Lights

Two red ENG RPM warning lights (Pilot and Copilot's) located on the top of the instrument panel, illuminate to alert the crew that the N_2 is below $89 \pm 1\%$. Additionally the low engine audio will be triggered at this same rpm.

1.8.2.7 Governor Caution Light

The GOV MANUAL caution light illuminates to alert pilot that respective governor switch is in MANUAL and pilot must control gas producer rpm with throttle.

1.8.2.8 Oil Pressure Caution Light

OIL PRESSURE caution light illuminates to alert crew that the engine oil pressure is below operating limits.

1.8.2.9 Chip Detector Caution Light

ENG CHIP caution light illuminates to alert crew that the engine chip detector has detected metal particles in engine oil.

• COPYRIGHT © 2007 BY DART AEROSPACE LTD •

This document is private and confidential and is supplied on the express condition that it is not to be used for any purpose or copied or communicated to any other person without written permission from Dart Aerospace Ltd.

Unapproved

Revision: **D**

Date: 10.05.12

The following table provides information on pilot alerts from the gauges:

Table 1-1

Instrument	Transient Limits (Digits begin to flash)	Threshold (min. reading)
DC Torquemeter	Alert Limit: Greater than 88% for more than 4 minutes OR greater than 95% Warning Limit: Greater than 88% for more than 5 minutes OR greater than 100%	5%
Ng Indicator	Greater than 105% rpm (73.5 Hz)	N/A
MGT Indicator	Alert Limit: Greater than 863°C (start mode) Greater than 820°C for more than 240 seconds OR greater than 853°C (operating mode) Warning Limit: Greater than 863°C for more than 5 seconds OR greater than 926°C (start mode) Greater than 820°C for more than 300 seconds OR greater than 863°C (operating mode)	350°C

• COPYRIGHT © 2007 BY DART AEROSPACE LTD •

This document is private and confidential and is supplied on the express condition that it is not to be used for any purpose or copied or communicated to any other person without written permission from Dart Aerospace Ltd.

Revision: **D**

Date: 10.05.12

Unapproved

1.9 Fuel System

Fuel is contained in five interconnected fuel cells (Figure 1-3), three aft of passenger compartment and two under passenger compartment floor. Two cells under floor are continuously supplied by gravity feed from three aft cells. If boost pump in either cell fails, there are two crossfeed tubes (1 forward and 1 aft) to allow fuel to transfer from the non-functioning tank to the functioning tank.

Each lower cell is separated into a forward and aft compartment by a baffle. Aft compartment contains a sump assembly equipped with an electrically operated boost pump, breakaway valve, flow activated switch, drain valve, defueling valve, and low level float switch. A fuel quantity probe is installed in each compartment. A flapper valve, in baffle, allows front to back flow and a hose assembly with an ejector type pump ensures this flow regardless of helicopter attitude. The interconnect valves, in line between forward compartments of both fuel cells and another between aft compartments is fixed opened to permit crossflow between cells when fuel level becomes low.

Three aft cells are aligned across fuselage. Each outboard cell feeds lower cell on same side. Interconnect lines are installed between outboard cells and center cell.

Fuel system filler port is located on right side of helicopter with an electrical ground receptacle for fuel nozzle located nearby.

1.9.1 Fuel System Controls

Fuel system controls consists of a fuel valve switch and boost pump switches.

1.9.1.1 Fuel Valve Switch

The ENGINE FUEL switch, located on pedestal, is a two position switch labeled ON and OFF that controls fuel flow from fuel tanks to engine. ON position provides power to fuel valve and arms ignition system. When switch

• COPYRIGHT © 2007 BY DART AEROSPACE LTD •

This document is private and confidential and is supplied on the express condition that it is not to be used for any purpose or copied or communicated to any other person without written permission from Dart Aerospace Ltd.

Revision: **D**

Date: 10.05.12

Unapproved

is OFF, power is removed and sump drain switches are powered so fuel sample can be taken from sump drain.

1.9.1.2 Boost Pump Switches

#1 BOOST PUMP and #2 BOOST PUMP switches, located on pedestal, are two position switches labeled ON and OFF. When in ON position, power is supplied to fuel cell mounted boost pumps and when in OFF position, power is removed from pumps.

1.9.2 Fuel System Indicators

Fuel system indicator includes fuel quantity indicator, fuel boost caution lights, fuel filter caution light, fuel low caution lights, and fuel valve caution light.

1.9.2.1 Fuel Quantity Indicator

S/Ns 30687, 30931 and 30576, Fuel quantity Indicator, located on instrument panel, displays total fuel quantity, left system quantity, and right system quantity depending on position of FUEL QTY SEL switch located to left of indicator. Fuel quantity is displayed in pounds x 100.

On all other S/Ns the FUEL QTY SEL switch has been removed and the FUEL QUANTITY INDICATOR only displays total fuel

1.9.2.2 Fuel Boost Caution Lights

#1 FUEL BOOST and #2 FUEL BOOST caution lights illuminate to alert crew that respective fuel boost pump pressure is low or pump has failed.

1.9.2.3 Fuel Filter Caution Lights

ENG FUEL FILTER caution light illuminates to alert crew that respective fuel filter is partially clogged.

1.9.2.4 Fuel Low Caution Lights

#1 FUEL LOW and #2 FUEL LOW caution lights illuminate to alert crew that fuel available to the engine is low (approximately 140 pounds remaining).

• COPYRIGHT © 2007 BY DART AEROSPACE LTD •

This document is private and confidential and is supplied on the express condition that it is not to be used for any purpose or copied or communicated to any other person without written permission from Dart Aerospace Ltd.

Revision: **D**

Date: 10.05.12

Unapproved



1.9.2.5 Fuel Valve Caution Lights

ENG FUEL VALVE caution light is normally illuminated during transit, and extinguish when valve position is same as that of switch. A fault is indicated if it does not extinguish.

• COPYRIGHT © 2007 BY DART AEROSPACE LTD •

This document is private and confidential and is supplied on the express condition that it is not to be used for any purpose or copied or communicated to any other person without written permission from Dart Aerospace Ltd.

Revision: **D**

Date: 10.05.12

Unapproved

1.10 Electrical Systems

1.10.1 DC Electrical System

Primary DC electrical power is supplied by a single 28 volt, 300 Amp, starter/generator. The power is distributed to the main DC buss. The main DC buss then provides power through the essential buss feeder circuit breakers to both the essential and nonessential busses. The nonessential buss is connected to the system through the nonessential buss relay and the nonessential buss load sensor. In the event that loads become too great, the load sensor will open the circuit and disconnect the nonessential buss from the system, leaving only the essential buss connected. The nonessential buss may be re-activated by placing the NON-ESS BUSS switch into the MANUAL position. A backup source of emergency power, in the event the starter/generator becomes inoperative, is provided by a 24 volt, 42 ampere hour lead-acid battery. Power for engine starting is provided by the battery or and external 28 VDC power source. Refer to Figure 1-4 for the electrical system schematic.

1.10.2 AC Electrical System

A secondary source of power, used to operate the equipment that requires alternating current is supplied by two 250 Volt-amp, single phase, solid state inverters.

For aircraft S/Ns 30687, 30931, 30576, 30817 and 30599, Inverter #1 normally feeds both the 115 VAC and the 26 VAC requirements of the helicopter, with Inverter #2 as a backup. In the event of inverter #1 failure, inverter #2 will automatically take over, provided the INV 2 switch is in the AUTO/ON position. An inverter blower will only operate when inverter #2 is supplying AC power to the busses.

For all aircraft except S/Ns 30687, 30931, 30576, 30817 and 30599, Inverter #1 will normally feed the 115VAC buss and Inverter #2 will normally feed the

• COPYRIGHT © 2007 BY DART AEROSPACE LTD •

This document is private and confidential and is supplied on the express condition that it is not to be used for any purpose or copied or communicated to any other person without written permission from Dart Aerospace Ltd.

Revision: **D**

Date: 10.05.12

Unapproved

26 VAC buss, provided INV2 switch is in the AUTO/ON position. In the event of a failure of either inverter, the other inverter will automatically supply power to the lost buss. Both inverters have internal cooling fans which operate when the inverter is powered.

Refer to Figure 1-4 for the electrical system schematic.

1.10.3 Electrical System Controls

Electrical system controls consist of one battery switch, a generator switch, nonessential bus switch, and two inverter switches.

1.10.3.1 Battery Switch

The battery switch, located on the overhead console, is a two position switch labeled OFF and ON. When the switch is selected to ON, the battery relay is closed and power is supplied to the main DC buss.

1.10.3.2 Generator Switch

The generator switch located on overhead console, is a three position switch labeled RESET, OFF, and ON. The switch controls flow of current to the main DC bus. When the switch is ON, generator output circuit is completed to reverse current relay and main DC bus. The switch is spring loaded to return to OFF when placed in RESET and released. RESET position is used to attempt to restore generator power to system. If the GENERATOR caution light illuminates, indicating system malfunction, switch should be placed in RESET momentarily, then moved to ON. If caution light extinguishes, system has returned to normal. OFF position removes generator output.

1.10.3.3 Nonessential Bus Switch

The NON-ESS BUS switch, located on the overhead console, is a two position switch labeled NORMAL and MANUAL which controls the nonessential buss relay. In the NORMAL position, if the generator fails or loads to the buss become excessive, the nonessential buss relay will open and power will be disconnected from the nonessential buss. When in the MANUAL position, the nonessential buss will be powered from the main DC

• COPYRIGHT © 2007 BY DART AEROSPACE LTD •

This document is private and confidential and is supplied on the express condition that it is not to be used for any purpose or copied or communicated to any other person without written permission from Dart Aerospace Ltd.

Revision: **D**

Date: 10.05.12

Unapproved

buss regardless of generator operation.

1.10.3.4 Inverter Switches

The INV 1 and INV 2 switches, located on overhead console, are two position switches labeled ON and OFF. When in ON position, power is supplied to respective inverter. When in OFF position, power is removed from respective inverter.

1.10.4 Electrical System Indicators

Electrical system indicators include a DC loadmeter and an AC/DC voltmeter, warning light, and caution lights.

1.10.4.1 DC Loadmeter

The DC loadmeter, located on instrument panel, displays electrical current loading for the generator.

1.10.4.2 AC/DC Voltmeter

The AC/DC voltmeter, located on instrument panel, display electrical output of the inverter and generator in volts.

1.10.4.3 Battery Caution Light

BATTERY caution light illuminates to alert pilot that battery relay is open and BATTERY switch is in ON position.

1.10.4.4 DC Generator Caution Light

The GENERATOR caution light illuminates to alert crew that the generator is not operating.

1.10.4.5 Inverter Caution Lights

INVERTER 1 and INVERTER 2 caution lights illuminate to alert crew that respective inverter is not operating.

1.10.4.6 External Power Caution Light

EXTERNAL POWER caution light illuminates when external power receptacle door is open.

• COPYRIGHT © 2007 BY DART AEROSPACE LTD •

This document is private and confidential and is supplied on the express condition that it is not to be used for any purpose or copied or communicated to any other person without written permission from Dart Aerospace Ltd.

Revision: **D**

Date: 10.05.12

Unapproved

1.11 Hydraulic Systems

Two separate hydraulic systems are used to assist cyclic, collective, and antitorque flight controls. Each system contains a reservoir, pump, integrated valve and filter assembly, accumulator, and check valves.

Each integrated valve and filter assembly contains a system pressure filter and a system return filter. In event any of these filters becomes partially clogged, a button on filter housing will pop out to give an indication of filter bypass. This button will also activate a switch which will cause a remote hydraulic filter bypass indicator, in lower right area of nose section, to switch from green to red or black to white. Remote bypass indicator can be seen on preflight check through right chin bubble.

Hydraulic pumps are driven by transmission and have different rated capacities. System 1 pump delivers a greater volume of fluid to operate anti-torque flight control servo actuator.

Cyclic and collective flight control servoactuators are each powered by both hydraulic systems, such that if either system fails, remaining system will operate servoactuators. Antitorque servoactuator is powered by system 1 only.

1.11.1 *Hydraulic System Controls*

HYDR SYS NO. 1 and HYDR SYS NO. 2 switches, located on pedestal, are two position switches labeled OFF and ON. When in ON position, hydraulic power is provided to flight control servo actuators and when in OFF position, hydraulic power is removed.

1.11.2 *Hydraulic System Indicators*

Hydraulic system indicators include dual temperature and pressure gage for each system and a caution light.

• COPYRIGHT © 2007 BY DART AEROSPACE LTD •

This document is private and confidential and is supplied on the express condition that it is not to be used for any purpose or copied or communicated to any other person without written permission from Dart Aerospace Ltd.

Revision: **D**

Date: 10.05.12

Unapproved

Helicopters serial number 30504 through 30596 incorporate a gage for temperature as well as for pressure for each system.

1.11.2.1 Hydraulic Temperature and Pressure Gages

Hydraulic temperature and pressure gages, mounted on instrument panel, display hydraulic oil temperature in degrees Celsius on left scale and hydraulic oil pressure in psi on right scale. On helicopters serial number 30504 through 30596 a gage is included for temperature as well as pressure for each hydraulic system.

1.11.2.2 Hydraulic System Caution Lights

HYDRAULIC caution light will illuminate to alert crew that hydraulic oil pressure has dropped below 650 psi or hydraulic oil temperature has exceeded 88 °C.

• COPYRIGHT © 2007 BY DART AEROSPACE LTD •

This document is private and confidential and is supplied on the express condition that it is not to be used for any purpose or copied or communicated to any other person without written permission from Dart Aerospace Ltd.

Unapproved

Revision: **D**

Date: 10.05.12

1.12 Flight Control System

Flight control system, consisting of cyclic, collective, and antitorque controls is used to control helicopter attitude, altitude, and direction of flight. Flight controls are hydraulically boosted to reduce pilot effort and to counteract control feedback forces,

Control inputs from cyclic, collective, and antitorque pedals are transmitted by pushpull tubes and bellcranks to hydraulic flight control servoactuators. Two cyclic flight control servo actuators are connected to swashplate, located above transmission. Swashplate converts fixed controls to rotating controls and actuates alternating cyclic pitch inputs to main rotor. Synchronized elevator is connected by control tubes and mechanical linkage to fore and aft cyclic control at swashplate. Fore and aft movement of cyclic produces a change in synchronized elevator attitude, thus increasing controllability and lengthening CG range.

Collective flight control servo actuator is connected to collective lever at swashplate support. Collective lever actuates collective sleeve, which moves mixing lever up and down to induce collective pitch into blades.

Antitorque flight control servo actuator is located in aft fuselage compartment near tailboom attachment area. Tail rotor fixed controls are connected to rotating controls through a bearing in crosshead assembly which slides along tail rotor output shaft to provide pitch change control.

Antitorque control pedals can be adjusted fore and aft by pressing and rotating a knob located on floor just forward of each crew seat,

1.12.1 Force Trim System

Cyclic and antitorque controls incorporate a force trim system to provide artificial control reaction forces when controls are manually moved from their reference positions.

• COPYRIGHT © 2007 BY DART AEROSPACE LTD •

This document is private and confidential and is supplied on the express condition that it is not to be used for any purpose or copied or communicated to any other person without written permission from Dart Aerospace Ltd.

Revision: **D**

Date: 10.05.12

Unapproved

Force trim components include spring-loaded force gradient cartridges connected in series with rotary trim actuators to fore/aft and lateral cyclic control and to antitorque control. When engaged, trim actuators become locked in position by internal magnetic brakes. Manual movement of controls then actuates force gradients which provide desired control resistance.

1.12.2 Force Trim Controls

Force trim system is activated by FORCE TRIM switch located on pedestal. A FORCE TRIM release switch, located on cyclic, can be pressed to de-energize system momentarily, allowing pilot to position cyclic and pedals for long term pitch, roll, and yaw corrections. Upon releasing switch, magnetic brakes are reenergized and will lock trim actuators in new reference positions existing at moment switch is released.

• COPYRIGHT © 2007 BY DART AEROSPACE LTD •

This document is private and confidential and is supplied on the express condition that it is not to be used for any purpose or copied or communicated to any other person without written permission from Dart Aerospace Ltd.

Unapproved

Revision: **D**

Date: 10.05.12

1.13 Pitot-Static System

Pitot system consists of an electrically heated pitot tube connected to airspeed indicator. A second, independent pitot system is installed when optional copilot instrument kit is installed.

Static system consists of static ports and tubing necessary to connect ports to airspeed indicator(s), altimeter(s), and vertical speed indicator(s). Two static ports are located just forward of crew doors.

1.14 Heating System

Cabin heating system, which includes windshield defrost system, uses bleed air from engine compressor section as source of heat. A mixing valve, which is controlled by a thermostat, mixes heated air with outside air to obtain desired temperature.

When windshield defrost is selected, heated air is diverted from doorpost and pedestal heater outlets to windshield nozzles.

1.15 Ventilating System

Ventilating system delivers outside air to outlets by instrument panel and also to windshield nozzles to defog windshield and provide fresh air ventilation. Overhead ventilation system delivers outside air through overhead nozzles to crew and passenger compartments.

• COPYRIGHT © 2007 BY DART AEROSPACE LTD •

This document is private and confidential and is supplied on the express condition that it is not to be used for any purpose or copied or communicated to any other person without written permission from Dart Aerospace Ltd.

Unapproved

Revision: **D**

Date: 10.05.12

1.16 Lighting Systems

1.16.1 *Interior Lighting*

Two multipurpose cockpit/map lights are mounted overhead in crew compartment. Either white or red light can be selected and light may be adjusted from spot beam to flood type illumination. These lights may be removed from their mounts for increased utility.

Three dome lights, with intensity adjustments, are mounted in passenger compartment. Dome lights illuminate red or white and are controlled by a switch, labeled AFT DOME LT OFF and BRT and rheostat, labeled WHITE, OFF, and RED, located on overhead console.

Two lights in cargo compartment are automatically illuminated when door is opened and nonessential DC bus 2 is energized.

Other interior lighting circuits include instrument panel lights (COPLT INSTR LT, ENG INSTR LT, PILOT INSTR LT), instrument secondary lights (SEC INSTR LT), overhead console lights (CONSOLE LT), and pedestal lights (PED LT) controlled by rheostats in overhead console,

Four self illuminating, beta lights are mounted over windows in passenger/cargo doors to identify emergency exits,

1.16.2 *Exterior Lighting*

Exterior lighting circuits include landing light, searchlight, position lights, anti-collision lights, and utility (step) lights. Landing light and searchlight are controlled by switches located on pilot collective. Remaining lights are controlled by switches located on overhead console.

• COPYRIGHT © 2007 BY DART AEROSPACE LTD •

This document is private and confidential and is supplied on the express condition that it is not to be used for any purpose or copied or communicated to any other person without written permission from Dart Aerospace Ltd.

Revision: **D**

Date: 10.05.12

Unapproved

1.17 Windshield Wipers

Electrically powered windshield wipers are mounted above windshields. Switches (WIPER SEL and WIPERS), located on overhead console, allow independent control of windshield wipers.

1.18 Rotor Brake System (If installed)

Rotor brake incorporates dual hydraulic systems which are independent of flight control hydraulic systems. Primary components include a dual master cylinder located on forward cabin roof, a brake disc with dual brake cylinders mounted on transmission, and associated hydraulic tubing. Two ROTOR BRAKE warning lights, on caution panel, are activated by micro switches in brake housing to warn pilot that brake is not fully released or the linings are not fully retracted,

Rotor brake application is limited to ground operation after the engine has been shut down and rotor rpm has decreased to 40%. Brake handle should be returned to full up detent position after blades stop. After securing main rotor blades, rotor brake may be locked to stabilize rotor during windy conditions.

• COPYRIGHT © 2007 BY DART AEROSPACE LTD •

This document is private and confidential and is supplied on the express condition that it is not to be used for any purpose or copied or communicated to any other person without written permission from Dart Aerospace Ltd.

Revision: **D**

Date: 10.05.12

Unapproved

1.19 Emergency Equipment

1.19.1 *Fire Detection*

A set of three infrared fire detectors are strategically mounted in the engine compartment.

For aircraft S/Ns 30687, 30931, 30576, 30817 and 30599, a fire condition will cause the FIRE PULL handle to illuminate.

For all aircraft except S/Ns 30687, 30931, 30576, 30817 and 30599, a fire condition will cause the guarded ENG FIRE light to illuminate at each pilot station.

A smoke detector is mounted at forward end of cargo compartment ceiling. Smoke in cargo compartment will cause CARGO FIRE warning light, located on instrument panel, to flash intermittently.

1.19.2 *Engine Fire Extinguishing System*

A fire extinguishing bottle is mounted in aft fuselage.

For aircraft S/Ns 30687, 30931, 30576, 30817 and 30599, pulling FIRE PULL handle de-energizes the heater bleed air valve and arms the fire extinguishing system. The EXTING switch may be used to discharge the bottle.

For all aircraft except S/Ns 30687, 30931, 30576, 30817 and 30599, pressing either ENG FIRE switchlight de-energizes the heater valve, arms the fire extinguishing system and illuminates the EXTING switchlight at each pilot station. Pressing either illuminated EXTING switchlight will discharge the fire bottle.

• COPYRIGHT © 2007 BY DART AEROSPACE LTD •

This document is private and confidential and is supplied on the express condition that it is not to be used for any purpose or copied or communicated to any other person without written permission from Dart Aerospace Ltd.

Unapproved

Revision: **D**

Date: 10.05.12

In either case, the fuel valve is not affected when the extinguishing system is armed.

1.19.3 *Portable Fire Extinguishers*

Two portable fire extinguishers are mounted in cabin, one on cabin floor to right of pilot seat and other on doorpost aft of copilot seat.

1.19.4 *First Aid Kit*

A portable first aid kit is attached to left side of pedestal by hook and pile fasteners.

1.19.5 *Emergency Exit – Door Jettison*

If crew doors can not be opened, door jettison can be accomplished by pulling jettison handles located on each crew door doorpost.

1.19.6 *Emergency Exit – Window Jettison*

If cabin sliding doors or hinged panels can not be opened, emergency escape is possible by pushing on lower corners of windows in sliding doors to jettison windows.

1.19.7 *Jettison Panels*

Escape panels on helicopters so equipped, may be jettisoned by removing plastic cover, turning D handle (inside or outside) and pushing panel out,

• COPYRIGHT © 2007 BY DART AEROSPACE LTD •

This document is private and confidential and is supplied on the express condition that it is not to be used for any purpose or copied or communicated to any other person without written permission from Dart Aerospace Ltd.

Revision: **D**

Date: 10.05.12

Unapproved

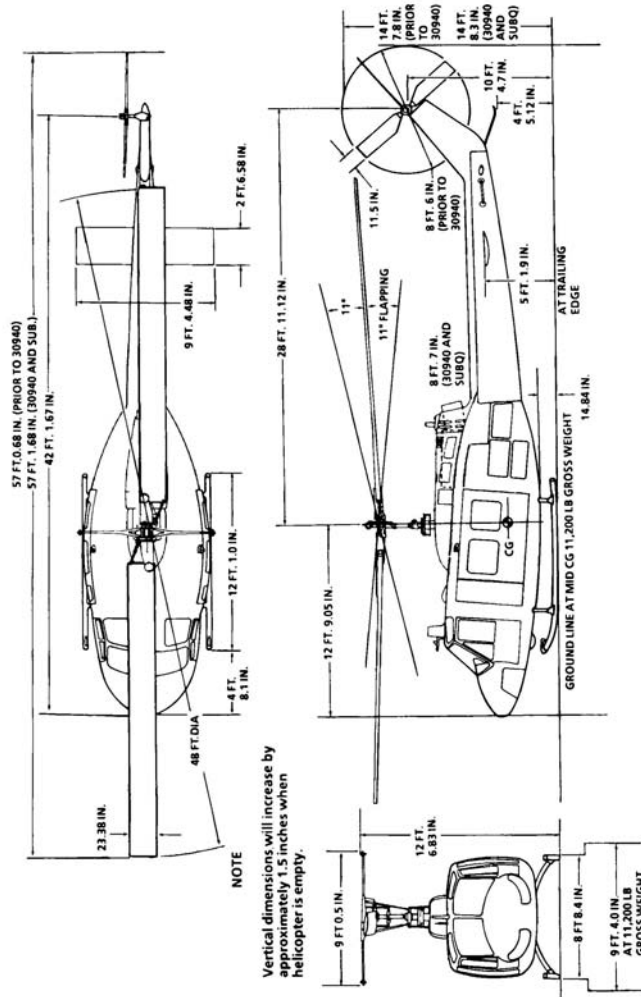

Figure 1-1 – Principal Exterior Dimensions

• COPYRIGHT © 2007 BY DART AEROSPACE LTD •
This document is private and confidential and is supplied on the express condition that it is not to be used for any purpose or copied or communicated to any other person without written permission from Dart Aerospace Ltd.

Unapproved

Revision: **D**
Date: 10.05.12



20 CUBIC FEET AVAILABLE IN COCKPIT

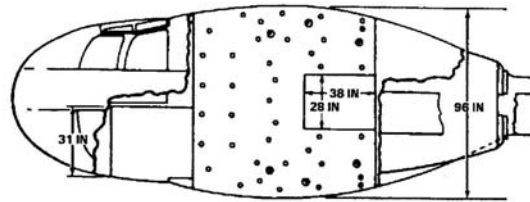

220 CUBIC FEET AVAILABLE IN CARGO AREA

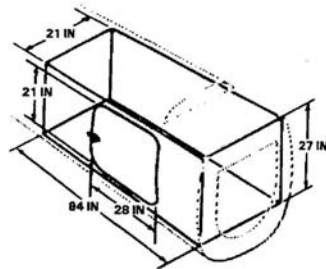

28 CUBIC FEET IN BAGGAGE COMPARTMENT

Figure 1-2 – Principal Interior Dimensions

• COPYRIGHT © 2007 BY DART AEROSPACE LTD •
This document is private and confidential and is supplied on the express condition that it is not to be used for any purpose or copied or communicated to any other person without written permission from Dart Aerospace Ltd.

Unapproved

Revision: **D**
Date: 10.05.12

1. Pressure transmitter
2. Manifold valve
3. Filter cap
4. Shutoff valves
5. Main fuel filter
6. Governor bleed lines
7. Vent lines
8. Fuel quantity probes
9. Center cell door
10. Crossover assemblies
11. Capped auxiliary fuel inlet
12. Sump assembly
13. Sump drain valve
14. Cell divider flapper valve
15. Forward drain valve
16. Forward interconnect valve
17. Ejector pump
18. Quantity gage probe
19. Cell vent line
20. Aft interconnect valve
21. Defuel valve
22. Fuel manifold drain line

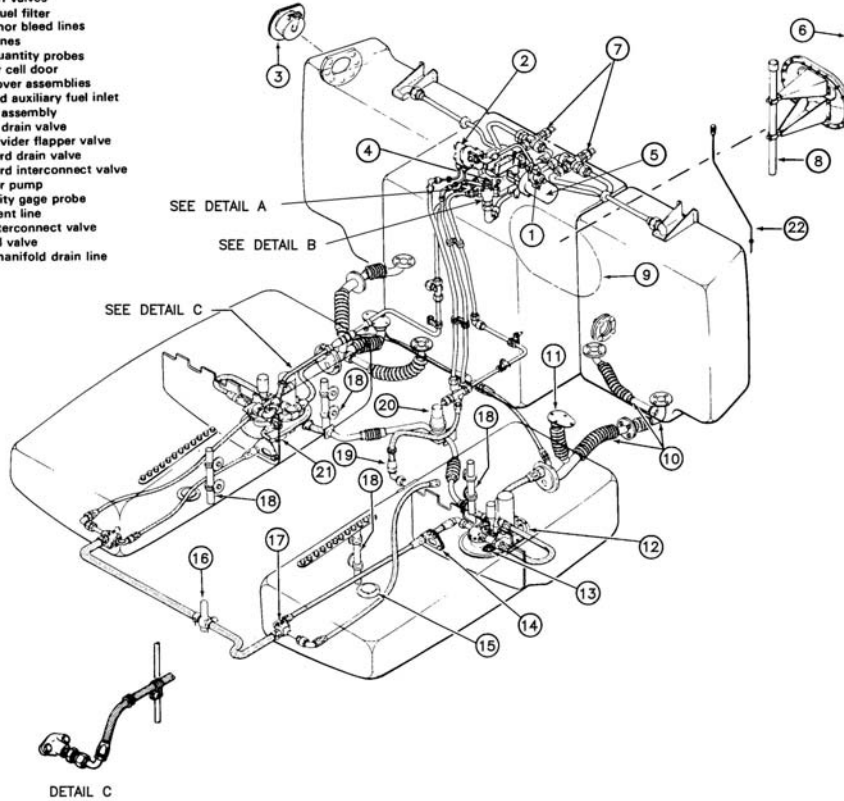

Figure 1-3 – Fuel System (Sheet 1 of 2)

• COPYRIGHT © 2007 BY DART AEROSPACE LTD •

This document is private and confidential and is supplied on the express condition that it is not to be used for any purpose or copied or communicated to any other person without written permission from Dart Aerospace Ltd.

Revision: **D**
Date: 10.05.12

Unapproved

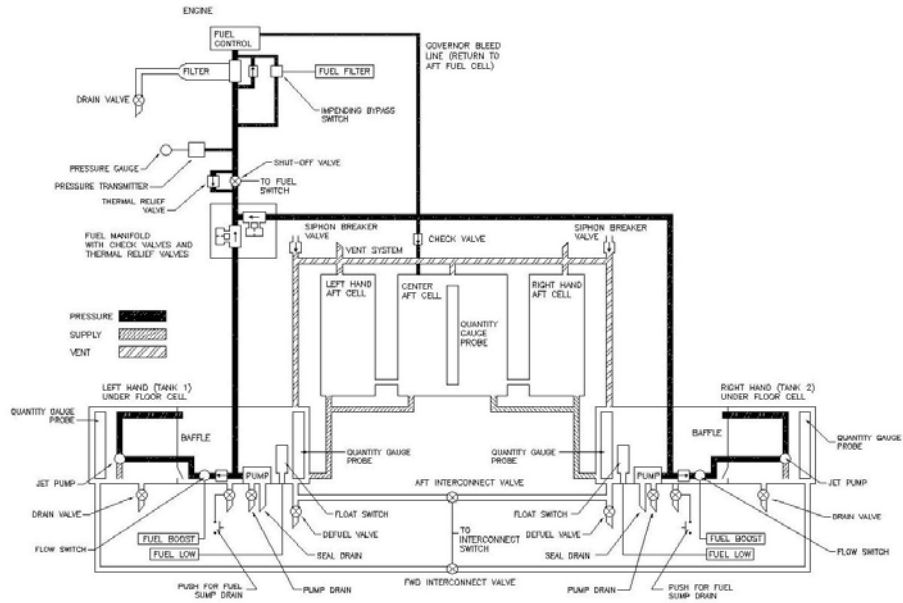

Figure 1-3 – Fuel System (Sheet 2 of 2)

• COPYRIGHT © 2007 BY DART AEROSPACE LTD •
This document is private and confidential and is supplied on the express condition that it is not to be used for any purpose or copied or communicated to any other person without written permission from Dart Aerospace Ltd.

Revision: **D**
Date: 10.05.12

Unapproved

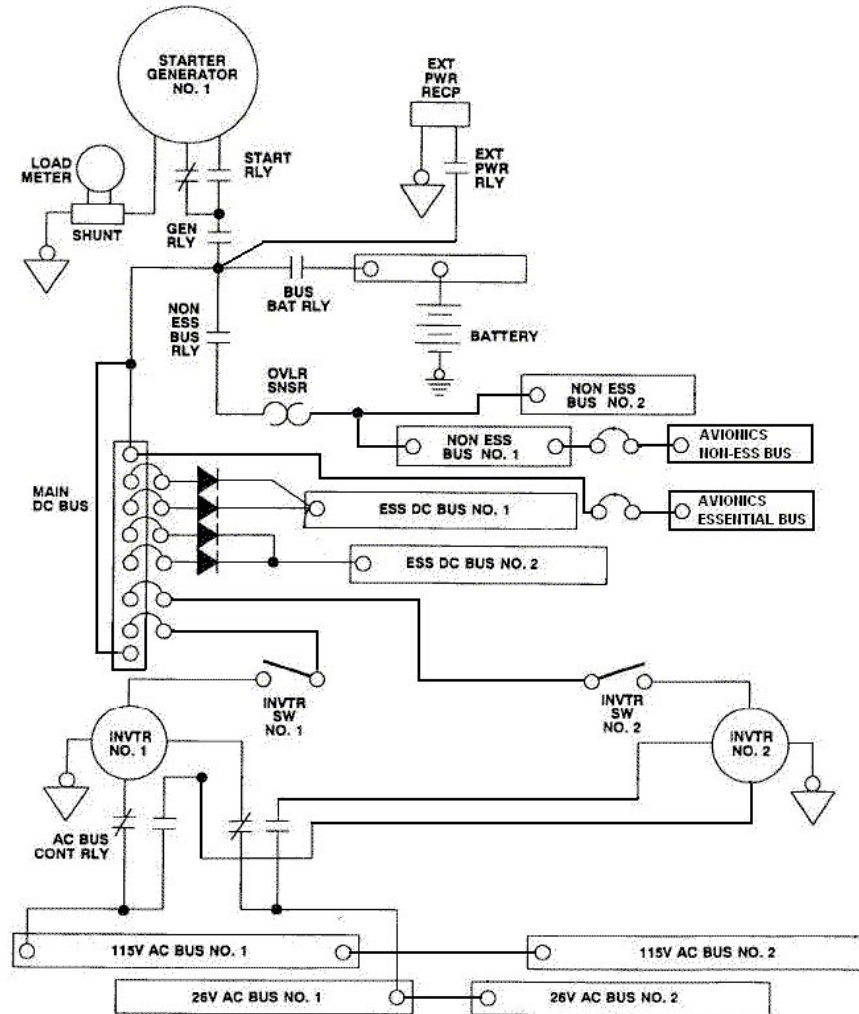

Figure 1-4 – Electrical System Schematic

• COPYRIGHT © 2007 BY DART AEROSPACE LTD •
This document is private and confidential and is supplied on the express condition that it is not to be used for any purpose or copied or communicated to any other person without written permission from Dart Aerospace Ltd.

Unapproved

Revision: **D**
Date: 10.05.12

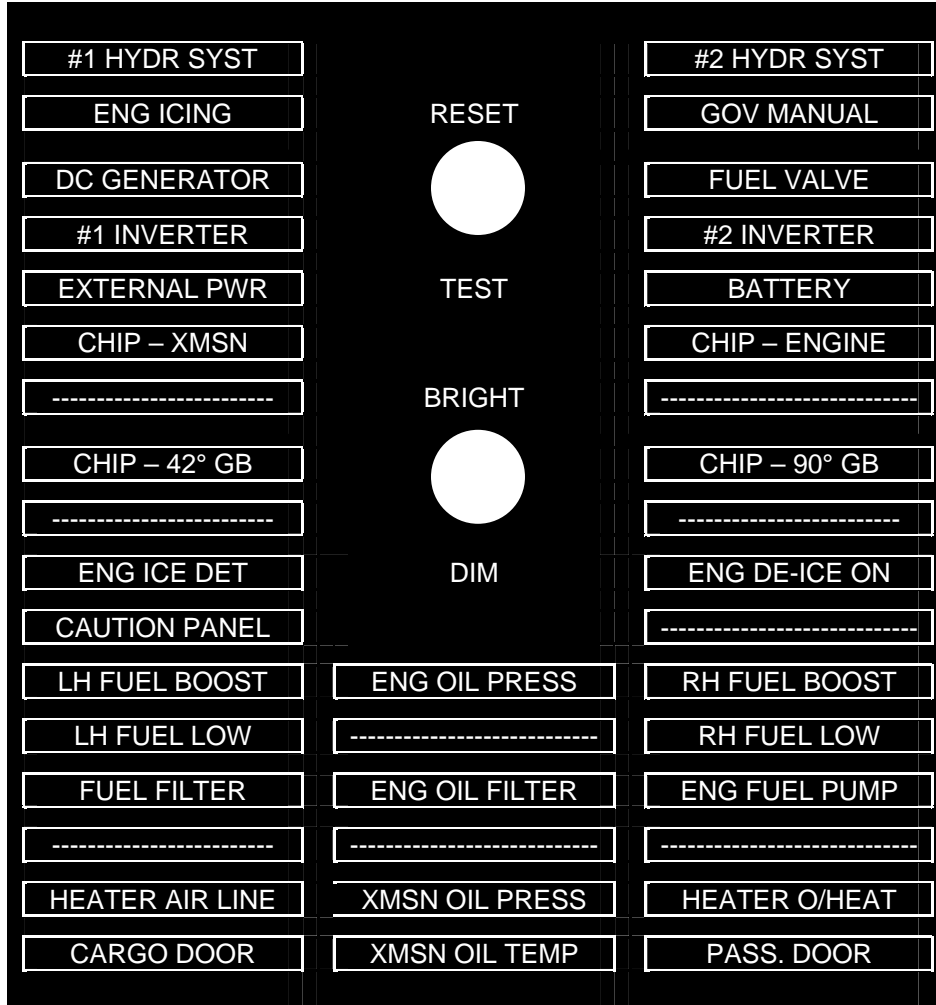

Figure 1-5 – Master Caution/Warning Panel – Typical

• COPYRIGHT © 2007 BY DART AEROSPACE LTD •
This document is private and confidential and is supplied on the express condition that it is not to be used for any purpose or copied or communicated to any other person without written permission from Dart Aerospace Ltd.

Revision: **D**
Date: 10.05.12

Unapproved

Section 2

Handling and Servicing

Table of Contents

2.1	Ground Handling.....	2-3
2.2	Towing	2-3
2.3	Parking and Securing	2-4
2.3.1	Tie Downs – Main Rotor.....	2-4
2.3.2	Tie Down – Tail Rotor.....	2-4
2.3.3	Cover – Engine Inlet.....	2-5
2.3.4	Cover – Engine Exhaust	2-5
2.3.5	Cover – Pitot Tube	2-5
2.3.6	Mooring	2-5
2.4	Fuels	2-6
2.4.1	Fuel System Servicing.....	2-8
2.5	Oils.....	2-9
2.5.1	Engine Oils	2-9
2.5.2	Engine Servicing	2-10
2.5.3	Transmission, Intermediate and Tail Rotor Gearbox Oils	2-11
2.5.4	Transmission, Intermediate and Tail Rotor Gearbox Servicing	2-14
2.6	Hydraulic Fluids	2-15
2.6.1	Hydraulic System Servicing	2-16
2.7	Rotor Brake Servicing.....	2-16
2.8	Main Rotor Hub Servicing.....	2-16

• COPYRIGHT © 2007 BY DART AEROSPACE LTD •

This document is private and confidential and is supplied on the express condition that it is not to be used for any purpose or copied or communicated to any other person without written permission from Dart Aerospace Ltd.

Unapproved

Revision: **A**

Date: 07.06.01



List of Tables

Table 2-1 – Commercial Type A and A-1 Fuels..... 2-6
 Table 2-2 – Commercial Type B Fuels 2-7
 Table 2-3 – Engine Oils (For any OAT) 2-10
 Table 2-4 – Engine Oils (For OAT above -40°C/-40°F) 2-10
 Table 2-5 – Transmission, Intermediate and Tail Rotor Gearbox Oils (For any OAT)..... 2-11
 Table 2-6 – Transmission, Intermediate and Tail Rotor Gearbox Oils (For OAT above -40°C/-40°F)..... 2-12
 Table 2-7 – Transmission, Intermediate and Tail Rotor Gearbox Oils (For OAT above -40°C/-40°F)..... 2-14
 Table 2-8 – Hydraulic Fluids 2-15

• COPYRIGHT © 2007 BY DART AEROSPACE LTD •
 This document is private and confidential and is supplied on the express condition that it is not to be used for any purpose or copied or communicated to any other person without written permission from Dart Aerospace Ltd.

Unapproved

Revision: **A**
Date: 07.06.01

Section 2

Handling and Servicing

2.1 Ground Handling

Ground handling of helicopter consists of towing, parking, securing, and mooring. Refer to Dart ICA-D212-725 for more detailed ground handling information.

2.2 Towing

Helicopter may be towed at walking speeds for very short distances using ground handling wheels and a standard tow bar.

Prior to movement, clear towing area of support equipment such as work stands, power units, fire extinguishers, etc., and disconnect static ground wire.

CAUTION

TOWING HELICOPTER ON UNPREPARED SURFACES OR ACROSS HANGAR DOOR TRACKS, ETC., AT GROSS WEIGHT IN EXCESS OF 9500 POUNDS (4309 KILOGRAMS) CAN CAUSE PERMANENT SET IN AFT CROSS TUBE.

IF HELICOPTER IS MOVED BY HAND, DO NOT PUSH ON ANY PART THAT COULD RESULT IN DAMAGE TO HELICOPTER, I.E., ANTENNAS, OPEN DOORS, ROTORS, ETC.

• COPYRIGHT © 2007 BY DART AEROSPACE LTD •

This document is private and confidential and is supplied on the express condition that it is not to be used for any purpose or copied or communicated to any other person without written permission from Dart Aerospace Ltd.

Unapproved

Revision: **A**

Date: 07.06.01

Station one person at tail skid to maintain helicopter in level position during towing.

2.3 Parking and Securing

Position helicopter in desired parking area on level surface when possible. Remove ground handling wheels and attach static ground wire to receptacle on lower, right, aft fuselage. Ensure all switches are in OFF position. Install approved tie downs on main and tail rotor blades.

For extended parking, disconnect battery, lock rotor brake, and close doors and windows, install protective covers on pitot tubes, engine air inlets, and exhaust stack.

2.3.1 Tie Downs – Main Rotor

Tie down main rotor blades when any of following conditions exist:

Thunderstorms are in local area or forecasted.

Winds in excess of 20 knots or a gust spread of 15 knots exist or is forecast.

Helicopter is parked within 150 feet of hovering or taxiing aircraft that are in excess of 11,600 pounds (5262 kilograms) GW.

Helicopter is to be parked overnight.

Main rotor tiedown is attached to blade and tiedown is then secured to tail boom. When secure, tie downs should be free of slack or under slight tension, but not under sufficient tension to appreciably flex main rotor blade.

2.3.2 Tie Down – Tail Rotor

Tail rotor tiedown is red and is stenciled in white letters – REMOVE BEFORE FLIGHT. To tie down tail rotor assembly, rotate main rotor until tail rotor blades are aligned with vertical fin and main rotor blades are aligned with

• COPYRIGHT © 2007 BY DART AEROSPACE LTD •

This document is private and confidential and is supplied on the express condition that it is not to be used for any purpose or copied or communicated to any other person without written permission from Dart Aerospace Ltd.

Unapproved

Revision: **A**
Date: 07.06.01

centerline of helicopter. Tie down main rotor first, then secure tail rotor to vertical fin with tiedown strap.

2.3.3 Cover – Engine Inlet

Engine inlet cover is made from red cloth with 2 red streamers stenciled in white letters – REMOVE BEFORE FLIGHT. The cover is attached with snaps to engine and transmission cowling.

2.3.4 Cover – Engine Exhaust

A cover is installed on the engine exhaust stack and is tied with a nylon cord in cover. Covers have red streamers on each side stenciled in white letters – REMOVE BEFORE FLIGHT.

2.3.5 Cover – Pitot Tube

Pitot tube covers are flame resistant and are attached with a red streamer stenciled in white letters – REMOVE BEFORE FLIGHT. Cover pitot tubes and tie cord to secure to pitot tubes.

2.3.6 Mooring

Mooring is securing helicopter to prevent damage during periods of high winds or turbulent weather. Helicopter should be moored, if parked in open, when forecast wind velocity is 45 knots (52 mph) or higher. If forecast wind velocity exceeds 75 knots (86 mph), helicopter should be hangared or evacuated to a safe area.

If helicopter is parked in open, helicopter should be positioned on a paved ramp between suitably spaced tiedown rings and should be headed in direction from which highest forecast winds are expected. Main and tail rotors should be properly secured with tie downs immediately after shutdown, during windy conditions, to minimize rotor flapping. Protective covers should be installed and fuel tanks should be serviced to maximum capacity with prescribed fuel to add weight to helicopter.

• COPYRIGHT © 2007 BY DART AEROSPACE LTD •

This document is private and confidential and is supplied on the express condition that it is not to be used for any purpose or copied or communicated to any other person without written permission from Dart Aerospace Ltd.

Unapproved

Revision: **A**

Date: 07.06.01

Fuselage mooring shackles should be secured to ramp tiedown points with rope, cable, or manufactured tiedown assemblies. If suitably spaced ramp tie downs are not available, helicopter should be parked on an unpaved surface and secured to subsurface mooring anchors or deadman anchors.

All ground support equipment and other objects which might be blown by wind should be properly secured. After winds subside, helicopter should be checked for damage.

2.4 Fuels

Fuels conforming to following commercial and military specifications are approved:

- ASTM D-1655, Type A, A-1, or B.
- MIL-T-5624, Grade JP-4 or JP-5.
- MIL-T-83133, Grade JP-8.

Refer to limitations in Section 1 of FMS-D212-725-1 for ambient temperature limits.

Fuel listings (Table 2-1 through 2-3) are provided for convenience of operator. It shall be responsibility of operator and his fuel supplier to ensure fuel conforms to one of approved specifications above.

Consult engine manufacturer for alternate or emergency fuels.

Table 2-1 – Commercial Type A and A-1 Fuels
(OAT Above -29°C/-20°F)

Fuel Vendor	Type A Product Name	Type A-1 Product Name
American Oil and Supply	American Jet Fuel Type A	American Jet Fuel Type A-1
ARCO (Atlantic Richfield)	Arcojet A	Arcojet A-1
Boron Oil	Jet A Kerosene	Jet A-1 Kerosene
British-American	B-A Jet Fuel JP-1	
British Petroleum	B.P. Jet A	BP. AT.K.

• COPYRIGHT © 2007 BY DART AEROSPACE LTD •

This document is private and confidential and is supplied on the express condition that it is not to be used for any purpose or copied or communicated to any other person without written permission from Dart Aerospace Ltd.

Revision: **A**

Date: 07.06.01

Unapproved

Table 2-1 – Commercial Type A and A-1 Fuels
(OAT Above -29°C/-20°F)

Fuel Vendor	Type A Product Name	Type A-1 Product Name
Caltex Petroleum		Caltex Jet A-1
Chevron	Chevron Jet A-SO	Chevron Jet A-1
Cities Service	Citgo Turbine Type A	
Continental	Conoco Jot-SO	Conoco Jet-GO
Exxon Co. U.S.A.	Exxon Turbo Fuel A	Exxon Turbo Fuel A-1
Exxon international		Esso Turbo Fuel A-1
Gulf Oil	Gulf Jet A	Gulf Jet A-1
Mobil Oil	Mobil Jet A	Mobil Jet A-1
Phillips Petroleum	Philjet A-So	
Pure Oil	Purejet Turbine Fuel Type A	Purejet Turbine Fuel Type A-1
Shell Oil	AeroShell Turbine Fuel 640	AeroShell Turbine Fuel 650 Chevron Jet Fuel A-1
Standard Oil of British Columbia	Chevron Jet Fuel A-50	
Standard Oil of California	Chevron Jet Fuel A-50	Chevron Jet Fuel A-1
Standard Oil of Indiana	American Jet Fuel Type A	American Jet Fuel Type A-1
Standard Oil of Kentucky	Standard Turbine Fuel A-50	Standard Turbine Fuel A-1
Standard Oil of New Jersey	Standard Jet A	Standard Jet A-1
Standard Oil of Ohio	Jet A Kerosene	Jet A-1 Kerosene
Standard Oil of Texas	Chevron Jet Fuel A-so	Chevron Jet Fuel A-1
Texaco	Texaco Avjet A	Texaco Avjet A-1
Union Oil	76 Turbine Fuel	

Table 2-2 – Commercial Type B Fuels
(For Any OAT)

Fuel Vendor	Type B Product Name
American Oil and Supply	American Jet JP-4
ARCO (Atlantic Richfield)	Arcojet B

• COPYRIGHT © 2007 BY DART AEROSPACE LTD •

This document is private and confidential and is supplied on the express condition that it is not to be used for any purpose or copied or communicated to any other person without written permission from Dart Aerospace Ltd.

Unapproved

Revision: **A**

Date: 07.06.01

Table 2-2 – Commercial Type B Fuels
(For Any OAT)

Fuel Vendor	Type B Product Name
British-American	B-A Jet Fuel JP-4
British Petroleum	B.P. A.T.G.
Caltex Petroleum	Caltex Jet B
Chevron	Chevron Jet B
Continental	Conoco JP-4
Exxon Co. U.S.A.	Exxon Turbo Fuel 4
Exxon international	Esso Turbo Fuel 4
Gulf Oil	Gulf Jet B
Mobil Oil	Mobil Jet B
Phillips Petroleum	Philjet JP-4
Shell Oil	AeroShell Turbine Fuel JP-4
Standard Oil of California	Chevron Jet Fuel B
Standard Oil of Indiana	American JP-4
Standard Oil of Kentucky	Standard Turbine Fuel B
Standard Oil of New Jersey	Standard Jet B
Standard Oil of Texas	Chevron Jet Fuel B
Texaco	Texaco Avjet B
Union Oil	Union JP-4

2.4.1 Fuel System Servicing

Total capacity is 219.6 U.S. gallons (831.3 liters).

Usable fuel is 216.8 U.S. gallons (820.6 liters) for helicopter serial numbers prior to 35049 and 218.6 U.S. gallons (827.4 liters) for helicopter serial numbers 35049 and subsequent.

Fuel system contains five interconnected fuel cells which are serviced through a single filler port on right side of aft fuselage. A grounding jack is provided adjacent to fueling port.

Electric sump drain valves are located in lower cells and are activated by

• COPYRIGHT © 2007 BY DART AEROSPACE LTD •

This document is private and confidential and is supplied on the express condition that it is not to be used for any purpose or copied or communicated to any other person without written permission from Dart Aerospace Ltd.

Revision: **A**

Date: 07.06.01

Unapproved

pushbutton switches located on each side of aft fuselage. BATTERY switch must be in ON position (or external power applied) and FUEL switches must be off to electrically activate sump drains.

2.5 Oils

Approved oils and vendors are listed for convenience of operator.

An appropriate entry shall be made in helicopter logbook when oil has been added to the engine, transmission, 42° (intermediate) gearbox, or 90° (tail rotor) gearbox. Entry shall show type and brand name of oil used to prevent inadvertent mixing of oils.

2.5.1 Engine Oils

Certain oils (Tables 2-4 through 2-6) which conform to following specifications are approved for use in the engine:

MIL-L-7808E (and subsequent suffixes) (NATO 0-148).

MIL-L-23699 (any suffix) (NATO 0-156).

Engine oils shall meet engine manufacturer's approval in all cases. Consult engine manufacturer for use of oil brands not listed herein.

CAUTION

DO NOT MIX BRANDS OR TYPES OF OILS. IF OILS BECOME MIXED, SYSTEM SHALL BE DRAINED AND FLUSHED.

Refer to Section 1 of FMS-D212-725-1 for ambient temperature limits.

• COPYRIGHT © 2007 BY DART AEROSPACE LTD •

This document is private and confidential and is supplied on the express condition that it is not to be used for any purpose or copied or communicated to any other person without written permission from Dart Aerospace Ltd.

Unapproved

Revision: **A**

Date: 07.06.01

Table 2-3 – Engine Oils (For any OAT)
MIL-L-7808 (NATO 0-148)

Oil Vendor	MIL-L-7808 Product Name
Exxon Co. U.S.A.	Exxon Turbo Oil 2389
Exxon International	Esso Turbo Oil 2389
Mobil Oil	Mobil Avrex S Turbo 256

Table 2-4 – Engine Oils (For OAT above -40°C/-40°F)
MIL-L-23699 (NATO 0-156)

Oil Vendor	MIL-L-23699 Product Name
Burmah-Castrol	Castrol 5000
Exxon Co. U.S.A.	Exxon Turbo Oil 23 80
Exxon international	Esso Turbo Oil 2300
Mobil Oil	Mobil Jet II
	Mobil Jet Oil (RM-254A)
NYCO S.A.	Turbonycoil 525-2A
Shell Oil	AeroShell Turbine Oil 5000
Stauffer Chemical	Stauffer Jet II

2.5.2 Engine Servicing

Engine oil capacity is 3.25 U.S. gallons (12.3 liters).

The engine's oil system has a filler and oil level sight glass. The sight glass is on aft side of the external oil tank, with access through aft right engine cowl.

Refer to engine maintenance manual for servicing instructions and oil filter change procedures.

• COPYRIGHT © 2007 BY DART AEROSPACE LTD •

This document is private and confidential and is supplied on the express condition that it is not to be used for any purpose or copied or communicated to any other person without written permission from Dart Aerospace Ltd.

Revision: **A**

Date: 07.06.01

Unapproved

2.5.3 Transmission, Intermediate and Tail Rotor Gearbox Oils

Oils listed in Tables 2-7 through 2-9 are approved for use in transmission, intermediate gearbox, and tail rotor gearbox. These oils conform to following specifications:

- MIL-L-7808E (and subsequent suffixes) (NATO 0-148).
- MIL-L-23699 (any suffix) (NATO 0-156).
- Turbine oil 555.

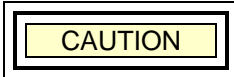

DO NOT MIX OILS OF DIFFERENT SPECIFICATIONS.
IF OILS BECOME MIXED, SYSTEM SHALL BE DRAINED AND FLUSHED.

Refer to Section 1 of FMS-D212-725-1 for ambient temperature limits.

Table 2-5 – Transmission, Intermediate and Tail Rotor Gearbox Oils (For any OAT)
MIL-L-7808 (NATO 0-148)

Oil Vendor	Turbine Oil 555 Product Name
American Oil and Supply	American PQ Lubricant 6899 American PQ Turbine Oil 8365 American PQ Turbine Oil 9900
Bray Oil	Brayco 880H
Burmah-Castrol (UH) Ltd.	Castrol 399
Exxon Co. U.S.A.	Exxon Turbo Oil 2389 Exxon Turbo Oil 2391
Exxon international	Esso Turbo Oil 2389 Esso Turbo Oil 2391
Hatco Chemical	Hatco 1278

• COPYRIGHT © 2007 BY DART AEROSPACE LTD •
This document is private and confidential and is supplied on the express condition that it is not to be used for any purpose or copied or communicated to any other person without written permission from Dart Aerospace Ltd.

Unapproved

Revision: **A**
Date: 07.06.01

Table 2-5 – Transmission, Intermediate and Tail Rotor Gearbox Oils (For any OAT)

MIL-L-7808 (NATO 0-148)

Oil Vendor	Turbine Oil 555 Product Name
Mobil Oil	Mobil RM-184A
	Mobil RM-201A
	Mobil RM-248A
	Mobil Avrex S Turbo 256
NYCO S.A.	Turbonycoil 160
NYCO International	NII 160
Royal Lubricants	Royco 808H
Shell International	AeroShell Turbine Oil 308
Stauffer Chemical	Stauffer Jet I

Table 2-6 – Transmission, Intermediate and Tail Rotor Gearbox Oils (For OAT above -40°C/-40°F)

MIL-L-23699 (NATO 0-156)

Oil Vendor	MIL-L-23699 Product Name
American Oil and Supply	American PQ Turbine Lubricant C-3788
	American PG Turbine Lubricant 3889
	American PG Turbine Lubricant 3893
	American PQ Turbine Lubricant 6423
	American PG Turbine Lubricant 6700
	American PG Turbine Lubricant 9598
Bray Oil	Brayco 899
	Brayco 899G
	Brayco 899M
Burmah-Castrol (UH) Ltd.	Castrol 5000
Castor Oils	Castrol 205
Emery Industries	Emgard Synthesized Turbine Lubricant (2949 or 2952)
Exxon Co. U.S.A.	Exxon Turbo Oil 2380
Exxon international	Esso Turbo Oil 2380

• COPYRIGHT © 2007 BY DART AEROSPACE LTD •

This document is private and confidential and is supplied on the express condition that it is not to be used for any purpose or copied or communicated to any other person without written permission from Dart Aerospace Ltd.

Revision: **A**

Date: 07.06.01

Unapproved

Table 2-6 – Transmission, Intermediate and Tail Rotor Gearbox Oils (For OAT above -40°C/-40°F)
MIL-L-23699 (NATO 0-156)

Oil Vendor	MIL-L-23699 Product Name
Hatco Chemical	Hatcol 1639
	Hatcol 1680
	Hatcol 3211
	Hatcol 3611
Mobil Oil	Mobil Jet Oil II
	Mobil RM-139A
	Mobil RM-147A
	Mobil RM-246A
	Mobil RM-247A
	Mobil RM-249A
	Mobil RM-254A
	Mobil RM-270A
	NYCO S.A.
Turbonycoil 599	
NYCO 599A	
NYCO 599B	
PVO International	STO-5700
Royal Lubricants	Royce Turbine Oil 500
	Royco 899 (C-915)
	Royco 899B (D-759-3)
	Royce 899C (D-758)
	Royco 899HC
	Royco 899 E-1
	Royco 899 E-2
Shell Oil	AeroShell Turbine Oil 500
Stauffer Chemical	Stauffer Jet II (6924)
	Stauffer STL (E-7306)

• COPYRIGHT © 2007 BY DART AEROSPACE LTD •

This document is private and confidential and is supplied on the express condition that it is not to be used for any purpose or copied or communicated to any other person without written permission from Dart Aerospace Ltd.

Unapproved

Revision: **A**

Date: 07.06.01

Table 2-7 – Transmission, Intermediate and Tail Rotor Gearbox Oils (For OAT above -40°C/-40°F)
Turbine Oil 555

Oil Vendor	Turbine Oil 555 Product Name
Royal Lubricants	Royco Turbine Oil 555
Shell International	AeroShell Turbine Oil 555

2.5.4 Transmission, Intermediate and Tail Rotor Gearbox Servicing

Transmission oil capacity is 11.0 U.S. quarts (10.4 liters).
Intermediate gearbox oil capacity is 0.2 U.S. quart (0.19 liter).
Tail rotor gearbox oil capacity is 0.4 U.S. quart (0.38 liter).

Transmission filler is located on upper right side of transmission and is accessible when forward pylon fairing is opened. Oil level sight glasses may be viewed through a window in right side of pylon support structure in cabin.

Intermediate and tail rotor gearboxes also incorporate oil level sight glasses. These oil levels should be verified by gently shaking tailboom laterally to agitate oil. This will ensure a false indication is not presented by a stained sight glass. Intermediate gearbox filler cap is accessible when gearbox fairing is removed.

NOTE

MIL-L-23699 and Turbine Oil 555 are not approved for use in ambient temperatures below -40°C (-40°F). When changing to an oil of a different specification, system shall be drained and flushed. Refer to BHT-212-MM for procedures for draining oil and cleaning or replacing filters.

• COPYRIGHT © 2007 BY DART AEROSPACE LTD •

This document is private and confidential and is supplied on the express condition that it is not to be used for any purpose or copied or communicated to any other person without written permission from Dart Aerospace Ltd.

Unapproved

Revision: **A**
Date: 07.06.01

2.6 Hydraulic Fluids

Hydraulic fluids listed in Table 2-10 conform to MIL-H-5606 (NATO H-515) and are approved for use in flight control hydraulic systems and rotor brake.

Table 2-8 – Hydraulic Fluids MIL-H-5606 (NATO H-515)	
Fluid Vendor	MIL-H-5606 Product Name
American Oil and Supply	PQ 2863
	PQ 2890
	PQ 2903
	PQ 2905
	PQ 2950
	PQ 3808
	PQ 4140
	PQ 4328
Bray Oil	Brayco 756E, 756ES, 756F
	Brayco 757B
	Brayco Micronic 756ES
Castor Oils	Castrol Hyspin A
Chevron U.S.A.	Chevron Aviation Hydraulic Fluid D (PED 5225)
Mobil Oil	Mobil Aero HFD
MZF Associates	25606
Penreco	Petrofluid 4146
	Petrofluid 4606
	Petrofluid 4607
Rohm and Haas	PA4394
Royal Lubricants	Royco 756C (C730-4)
	Royco 756D, 7546E
	DS-437
Shell International	AeroShell Fluid 41
Stauffer Chemical	Stauffer Aero Hydroil 500
	Aircraft Hydraulic Oil 15
Texaco	TL-10711A

• COPYRIGHT © 2007 BY DART AEROSPACE LTD •

This document is private and confidential and is supplied on the express condition that it is not to be used for any purpose or copied or communicated to any other person without written permission from Dart Aerospace Ltd.

Unapproved

Revision: **A**

Date: 07.06.01

2.6.1 Hydraulic System Servicing

Reservoir capacity (each) is 2.6 U.S. quarts (2.5 liters).

Two hydraulic reservoirs are located on top of fuselage, forward of transmission and under forward pylon fairing. Sight glass is provided to determine quantity of hydraulic fluid in each reservoir.

Service each hydraulic system as follows:

Open forward pylon fairing.

Remove cap and fill reservoir until sight glass is full of hydraulic fluid.

Secure cap and close fairing.

Refer to BHT-212-MM for filter change procedures.

2.7 Rotor Brake Servicing

System capacity is 1.0 U.S. pint (0.47 liter).

Rotor brake reservoir (if installed) is mounted in right side of cabin roof between overhead windows. Brake is serviced through a filler cap located on top of cabin roof.

2.8 Main Rotor Hub Servicing

Oils conforming to following specifications are approved for use in main rotor blade grips and trunnion pillow blocks:

MIL-L-7808E (and subsequent suffixes) (NATO 0-148)

MIL-L-23699 (any suffix) (NATO 0-156)

MIL-L-46152 (SAE 10W30 multi-viscosity)

NOTE

Main rotor blade grips and pillow blocks modified for grease lubrication require MIL-G-81322. Refer to BHT Technical Bulletin No. 212-81-56.

Main rotor blade grip capacity (each) is 1.0 US. quart (0.9 liter).

• COPYRIGHT © 2007 BY DART AEROSPACE LTD •

This document is private and confidential and is supplied on the express condition that it is not to be used for any purpose or copied or communicated to any other person without written permission from Dart Aerospace Ltd.

Revision: **A**

Date: 07.06.01

Unapproved



Section 3

Conversion Charts and Tables

List of Tables and Figures

Table 3-1 – Centigrade – Fahrenheit Conversion Table3-3
 Table 3-2 – Gallons to Liters Conversion Table3-5
 Table 3-3 – Inches to Millimeters Conversion3-6
 Table 3-4 – Feet to Meters Conversion3-7
 Table 3-5 – Pounds to Kilograms Conversion Table3-8
 Table 3-6 – Velocity Conversion.....3-9
 Table 3-7 – Barometric Pressure Conversion3-10
 Table 3-8 – Barometric Pressure Conversion3-12
 Figure 3-1 – Density Altitude3-13

• COPYRIGHT © 2007 BY DART AEROSPACE LTD •

This document is private and confidential and is supplied on the express condition that it is not to be used for any purpose or copied or communicated to any other person without written permission from Dart Aerospace Ltd.

Unapproved

Revision: **A**

Date: 07.06.01



Section 3

Conversion Charts and Tables

This section contains conversion charts and tables which may be useful for operational planning. Additional charts/tables may be added as deemed necessary.

• COPYRIGHT © 2007 BY DART AEROSPACE LTD •

This document is private and confidential and is supplied on the express condition that it is not to be used for any purpose or copied or communicated to any other person without written permission from Dart Aerospace Ltd.

Unapproved

Revision: **A**
Date: 07.06.01

Table 3-1 – Centigrade – Fahrenheit Conversion Table

$$^{\circ}\text{F} = 9/5 \text{ }^{\circ}\text{C} + 32$$

$$^{\circ}\text{C} = 5/9 (\text{ }^{\circ}\text{F} - 32)$$

$^{\circ}\text{C}$	$^{\circ}\text{F}$	$^{\circ}\text{C}$	$^{\circ}\text{F}$	$^{\circ}\text{C}$	$^{\circ}\text{F}$
-80	-112	75	167	205	401
-70	-94	80	176	210	410
-60	-76	85	185	215	419
-50	-58	90	194	220	428
-40	-40	95	203	225	437
-30	-22	100	212	230	446
-25	-13	105	221	235	455
-20	-4	110	230	240	464
-15	5	115	239	245	473
-10	14	120	248	250	482
-5	23	125	257	260	500
0	32	130	266	270	518
5	41	135	275	279	534
10	50	140	284	290	554
15	59	145	293	300	572
20	68	150	302	310	590
25	77	155	311	320	608
30	86	160	320	330	626
34	93	165	329	340	644
40	104	170	338	350	662
45	113	175	347	360	680
50	122	180	356	370	698
55	131	185	365	380	716
60	140	190	374	390	734
65	149	195	383	400	752
70	158	200	392	410	770

• COPYRIGHT © 2007 BY DART AEROSPACE LTD •

This document is private and confidential and is supplied on the express condition that it is not to be used for any purpose or copied or communicated to any other person without written permission from Dart Aerospace Ltd.

Unapproved

Revision: **A**

Date: 07.06.01



°C	°F	°C	°F	°C	°F
420	788	530	986	680	1256
430	806	540	1004	700	1292
440	824	550	1022	720	1328
450	842	560	1040	740	1364
460	860	570	1058	760	1400
470	878	580	1076	780	1436
480	896	590	1094	800	1472
490	914	600	1112	850	1562
500	932	620	1148	900	1652
510	950	640	1184	950	1742
520	968	660	1220	1000	1832

• COPYRIGHT © 2007 BY DART AEROSPACE LTD •

This document is private and confidential and is supplied on the express condition that it is not to be used for any purpose or copied or communicated to any other person without written permission from Dart Aerospace Ltd.

Unapproved

Revision: **A**
Date: 07.06.01

Table 3-2 – Gallons to Liters Conversion Table

Gallons to Litres Conversion Table						
US Gallons	Imperial Gallons	Litres		US Gallons	Imperial Gallons	Litres
10	8.33	37.85		170	141.55	643.50
20	16.65	75.71		180	149.88	681.35
30	24.98	113.56		190	158.21	719.21
40	33.31	151.41		200	166.53	757.06
50	41.63	189.27		210	174.86	794.91
60	49.96	227.12		220	183.19	832.77
70	58.29	264.97		230	191.51	870.62
80	66.61	302.82		240	199.84	908.47
90	74.94	340.68		250	208.17	946.33
100	83.27	378.53		260	216.49	984.18
110	91.59	416.38		270	224.82	1022.03
120	99.92	454.24		280	233.15	1059.88
130	108.25	492.09		290	241.47	1097.74
140	116.57	529.94		300	249.80	1135.59
150	124.90	567.80		310	258.13	1173.44
160	133.23	605.65		320	266.45	1211.30

• COPYRIGHT © 2007 BY DART AEROSPACE LTD •

This document is private and confidential and is supplied on the express condition that it is not to be used for any purpose or copied or communicated to any other person without written permission from Dart Aerospace Ltd.

Unapproved

Revision: **A**

Date: 07.06.01



Table 3-3 – Inches to Millimeters Conversion

Inches	0	1	2	3	4	5	6	7	8	9
	Mm.	Mm.	Mm.	Mm.	Mm.	Mm.	Mm.	Mm.	Mm.	Mm.
0	0.00	25.40	50.80	76.20	101.60	127.00	152.40	177.80	203.20	228.60
10	254.00	279.40	304.80	330.20	355.60	381.00	406.40	431.80	457.20	482.60
20	508.00	533.40	558.80	584.20	609.60	635.00	660.40	685.80	711.20	736.60
30	762.00	787.40	812.80	838.20	863.60	889.00	914.40	939.80	965.20	990.60
40	1016.00	1041.40	1066.80	1092.20	1117.60	1143.00	1168.40	1193.80	1219.20	1244.60
50	1270.00	1295.40	1320.80	1346.20	1371.60	1397.00	1422.40	1447.80	1473.20	1498.60
60	1524.00	1549.40	1574.80	1600.20	1625.60	1651.00	1676.40	1701.80	1727.20	1752.60
70	1778.00	1803.40	1828.80	1854.20	1879.60	1905.00	1930.40	1955.80	1981.20	2006.60
80	2032.00	2057.40	2082.80	2108.20	2133.60	2159.00	2184.40	2209.80	2235.20	2260.60
90	2286.00	2311.40	2336.80	2362.20	2387.60	2413.00	2438.40	2463.80	2489.20	2514.60
100	2540.00	2565.40	2590.80	2616.20	2641.60	2667.00	2692.40	2717.80	2743.20	2768.60

• COPYRIGHT © 2007 BY DART AEROSPACE LTD •

This document is private and confidential and is supplied on the express condition that it is not to be used for any purpose or copied or communicated to any other person without written permission from Dart Aerospace Ltd.

Unapproved

Revision: **A**
Date: 07.06.01

Table 3-4 – Feet to Meters Conversion

Feet	Meters	Meters	Meters	Meters	Meters	Meters	Meters	Meters	Meters	Meters	Meters	Meters	Meters	Meters	Meters	Meters	Meters	Meters	Meters																																																																																											
0	0.000	0.305	0.610	0.914	1.219	1.524	1.829	2.134	2.438	2.743	3.048	3.353	3.658	3.962	4.267	4.572	4.877	5.182	5.486	5.791	6.096	6.401	6.706	7.010	7.315	7.620	7.925	8.230	8.534	8.839	9.144	9.449	9.754	10.058	10.363	10.668	10.973	11.278	11.582	11.887	12.192	12.497	12.802	13.106	13.411	13.716	14.021	14.326	14.630	14.935	15.240	15.545	15.850	16.154	16.459	16.764	17.069	17.374	17.678	17.983	18.288	18.593	18.898	19.202	19.507	19.812	20.117	20.422	20.726	21.031	21.336	21.641	21.946	22.250	22.555	22.860	23.165	23.470	23.774	24.079	24.384	24.689	24.994	25.298	25.603	25.908	26.213	26.518	26.822	27.127	27.432	27.737	28.042	28.346	28.651	28.956	29.261	29.566	29.870	30.175	30.480	30.785	31.090	31.394	31.699	32.004	32.309	32.614	32.918	33.223

• COPYRIGHT © 2007 BY DART AEROSPACE LTD •

This document is private and confidential and is supplied on the express condition that it is not to be used for any purpose or copied or communicated to any other person without written permission from Dart Aerospace Ltd.

Unapproved

Revision: **A**
Date: 07.06.01



Table 3-5 – Pounds to Kilograms Conversion Table

Pounds	Kilogram S	0	1	2	3	4	5	6	7	8	9
0	Kilogram S	0.000	0.454	0.907	1.361	1.814	2.268	2.722	3.175	3.629	4.082
10	Kilogram S	4.536	4.990	5.443	5.897	6.350	6.804	7.258	7.711	8.165	8.618
20	Kilogram S	9.072	9.526	9.979	10.433	10.886	11.340	11.794	12.247	12.701	13.154
30	Kilogram S	13.608	14.062	14.515	14.969	15.422	15.876	16.330	16.783	17.237	17.690
40	Kilogram S	18.144	18.598	19.051	19.505	19.958	20.412	20.866	21.319	21.773	22.226
50	Kilogram S	22.680	23.134	23.587	24.041	24.494	24.948	25.402	25.855	26.309	26.762
60	Kilogram S	27.216	27.670	28.123	28.577	29.030	29.484	29.938	30.391	30.845	31.298
70	Kilogram S	31.752	32.206	32.659	33.113	33.566	34.020	34.474	34.927	35.381	35.834
80	Kilogram S	36.288	36.742	37.195	37.649	38.102	38.556	39.010	39.463	39.917	40.370
90	Kilogram S	40.824	41.278	41.731	42.185	42.638	43.092	43.546	43.999	44.453	44.906
100	Kilogram S	45.360	45.814	46.267	46.721	47.174	47.628	48.082	48.535	48.989	49.442

• COPYRIGHT © 2007 BY DART AEROSPACE LTD •

This document is private and confidential and is supplied on the express condition that it is not to be used for any purpose or copied or communicated to any other person without written permission from Dart Aerospace Ltd.

Revision: **A**

Date: 07.06.01

Unapproved

Table 3-6 – Velocity Conversion

Velocity Conversion								
Knots	MPH	Km/Hr	m/sec		Knots	MPH	Km/Hr	m/sec
5	5.8	9.3	2.6		105	120.8	194.5	54.0
10	11.5	18.5	5.1		110	126.6	203.7	56.6
15	17.3	27.8	7.7		115	132.3	213.0	59.2
20	23.0	37.0	10.3		120	138.1	222.2	61.7
25	28.8	46.3	12.9		125	143.8	231.5	64.3
30	34.5	55.6	15.4		130	149.6	240.8	66.9
35	40.3	64.8	18.0		135	155.4	250.0	69.5
40	46.0	74.1	20.6		140	161.1	259.3	72.0
45	51.8	83.3	23.2		145	166.9	268.5	74.6
50	57.5	92.6	25.7		150	172.6	277.8	77.2
55	63.3	101.9	28.3		155	178.4	287.1	79.7
60	69.0	111.1	30.9		160	184.1	296.3	82.3
65	74.8	120.4	33.4		165	189.9	305.6	84.9
70	80.6	129.6	36.0		170	195.6	314.8	87.5
75	86.3	138.9	38.6		175	201.4	324.1	90.0
80	92.1	148.2	41.2		180	207.1	333.4	92.6
85	97.8	157.4	43.7		185	212.9	342.6	95.2
90	103.6	166.7	46.3		190	218.6	351.9	97.7
95	109.3	175.9	48.9		195	224.4	361.1	100.3
100	115.1	185.2	51.4		200	230.2	370.4	102.9

• COPYRIGHT © 2007 BY DART AEROSPACE LTD •

This document is private and confidential and is supplied on the express condition that it is not to be used for any purpose or copied or communicated to any other person without written permission from Dart Aerospace Ltd.

Unapproved

Revision: **A**

Date: 07.06.01



Table 3-7 – Barometric Pressure Conversion
Inches of Mercury to Millibars

Mercury	0	0.01	0.02	0.03	0.04	0.05	0.06	0.07	0.08	0.09
Inches	Millibars									
28.0	948.2	948.5	948.9	949.2	949.5	949.9	950.2	950.6	950.9	951.2
28.1	951.6	951.9	952.3	952.6	952.9	953.3	953.6	953.9	954.3	954.6
28.2	955.0	955.3	955.6	956.0	956.3	956.7	957.0	957.3	957.7	958.0
28.3	958.3	958.7	959.0	959.4	959.7	960.0	960.4	960.7	961.1	961.4
28.4	961.7	962.1	962.4	962.7	963.1	963.4	963.8	964.1	964.4	964.8
28.5	965.1	965.5	965.8	966.1	966.5	966.8	967.2	967.5	967.8	968.2
28.6	968.5	968.8	969.2	969.5	969.9	970.2	970.5	970.9	971.2	971.6
28.7	971.9	972.2	972.6	972.9	973.2	973.6	973.9	974.3	974.6	974.9
28.8	975.3	975.6	976.0	976.3	976.6	977.0	977.3	977.6	978.0	978.3
28.9	978.7	979.0	979.3	979.7	980.0	980.4	980.7	981.0	981.4	981.7
29.0	982.1	982.4	982.7	983.1	983.4	983.7	984.1	984.4	984.8	985.1
29.1	985.4	985.8	986.1	986.5	986.8	987.1	987.5	987.8	988.1	988.5
29.2	988.8	989.2	989.5	989.8	990.2	990.5	990.9	991.2	991.5	991.9
29.3	992.2	992.5	992.9	993.2	993.6	993.9	994.2	994.6	994.9	995.3
29.4	995.6	995.9	996.3	996.6	997.0	997.3	997.6	998.0	998.3	998.6
29.5	999.0	999.3	999.7	1000.0	1000.3	1000.7	1001.0	1001.4	1001.7	1002.0
29.6	1002.4	1002.7	1003.0	1003.4	1003.7	1004.1	1004.4	1004.7	1005.1	1005.4
29.7	1005.8	1006.1	1006.4	1006.8	1007.1	1007.5	1007.8	1008.1	1008.5	1008.8
29.8	1009.1	1009.5	1009.8	1010.2	1010.5	1010.8	1011.2	1011.5	1011.9	1012.2
29.9	1012.5	1012.9	1013.2	1013.5	1013.9	1014.2	1014.6	1014.9	1015.2	1015.6
30.0	1015.9	1016.3	1016.6	1016.9	1017.3	1017.6	1017.9	1018.3	1018.6	1019.0
30.1	1019.3	1019.6	1020.0	1020.3	1020.7	1021.0	1021.3	1021.7	1022.0	1022.4
30.2	1022.7	1023.0	1023.4	1023.7	1024.0	1024.4	1024.7	1025.1	1025.4	1025.7

• COPYRIGHT © 2007 BY DART AEROSPACE LTD •

This document is private and confidential and is supplied on the express condition that it is not to be used for any purpose or copied or communicated to any other person without written permission from Dart Aerospace Ltd.

Revision: **A**
Date: 07.06.01

Unapproved



Mercury	0	0.01	0.02	0.03	0.04	0.05	0.06	0.07	0.08	0.09
Inches	Millibars									
30.3	1026.1	1026.4	1026.8	1027.1	1027.4	1027.8	1028.1	1028.4	1028.8	1029.1
30.4	1029.5	1029.8	1030.1	1030.5	1030.8	1031.2	1031.5	1031.8	1032.2	1032.5
30.5	1032.8	1033.2	1033.5	1033.9	1034.2	1034.5	1034.9	1035.2	1035.6	1035.9
30.6	1036.2	1036.6	1036.9	1037.3	1037.6	1037.9	1038.3	1038.6	1038.9	1039.3
30.7	1039.6	1040.0	1040.3	1040.6	1041.0	1041.3	1041.7	1042.0	1042.3	1042.7
30.8	1043.0	1043.3	1043.7	1044.0	1044.4	1044.7	1045.0	1045.4	1045.7	1046.1
30.9	1046.4	1046.7	1047.1	1047.4	1047.7	1048.1	1048.4	1048.8	1049.1	1049.4

• COPYRIGHT © 2007 BY DART AEROSPACE LTD •

This document is private and confidential and is supplied on the express condition that it is not to be used for any purpose or copied or communicated to any other person without written permission from Dart Aerospace Ltd.

Unapproved

Revision: **A**

Date: 07.06.01



Table 3-8 – Barometric Pressure Conversion
Millibars to Inches of Mercury

	0	1	2	3	4	5	6	7	8	9
Millibars	Inches									
940	27.76	27.79	27.82	27.85	27.88	27.91	27.94	27.96	27.99	28.02
950	28.05	28.08	28.11	28.14	28.17	28.20	28.23	28.26	28.29	28.32
960	28.35	28.38	28.41	28.44	28.47	28.50	28.53	28.56	28.59	28.61
970	28.64	28.67	28.70	28.73	28.76	28.79	28.82	28.85	28.88	28.91
980	28.94	28.97	29.00	29.03	29.06	29.09	29.12	29.15	29.18	29.21
990	29.23	29.26	29.29	29.32	29.35	29.38	29.41	29.44	29.47	29.50
1000	29.53	29.56	29.59	29.62	29.65	29.68	29.71	29.74	29.77	29.80
1010	29.83	29.85	29.88	29.91	29.94	29.97	30.00	30.03	30.06	30.09
1020	30.12	30.15	30.18	30.21	30.24	30.27	30.30	30.33	30.36	30.39
1030	30.42	30.45	30.47	30.50	30.53	30.56	30.59	30.62	30.65	30.68
1040	30.71	30.74	30.77	30.80	30.83	30.86	30.89	30.92	30.95	30.98
1050	31.01	31.04	31.07	31.10	31.12	31.15	31.18	31.21	31.24	31.27

• COPYRIGHT © 2007 BY DART AEROSPACE LTD •

This document is private and confidential and is supplied on the express condition that it is not to be used for any purpose or copied or communicated to any other person without written permission from Dart Aerospace Ltd.

Unapproved

Revision: **A**
Date: 07.06.01

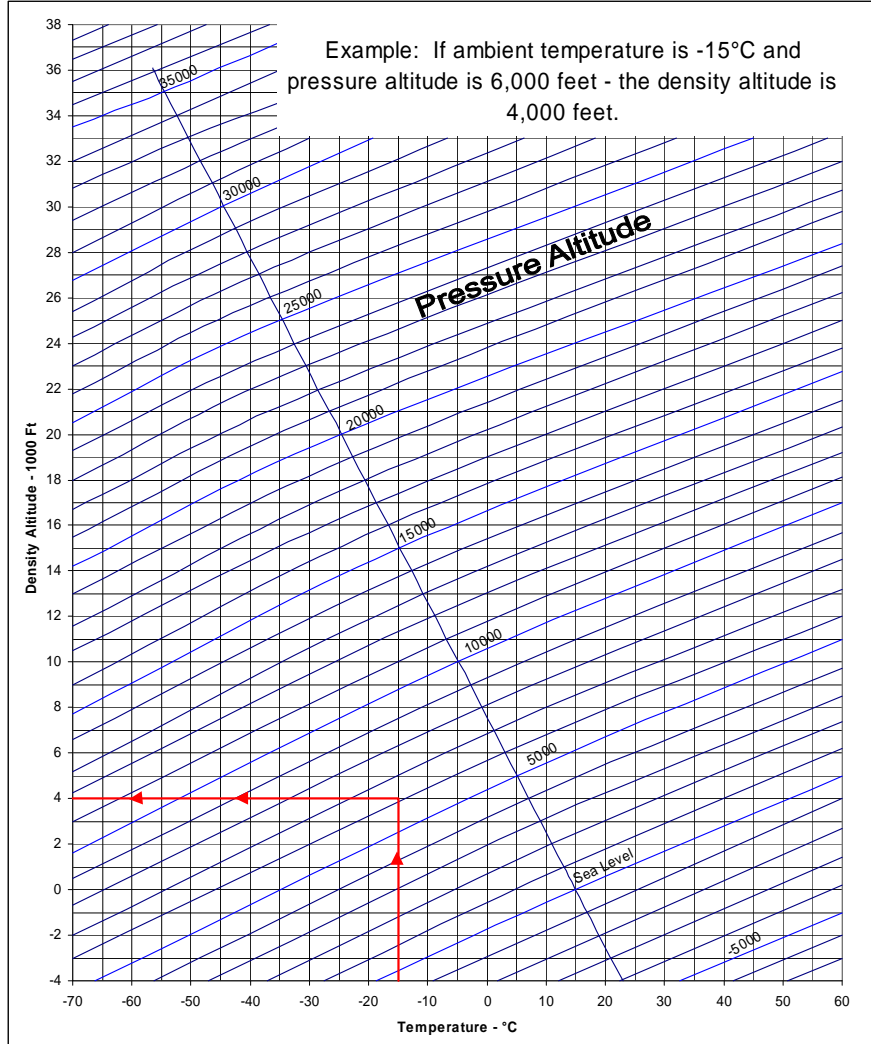

Figure 3-1 – Density Altitude

• COPYRIGHT © 2007 BY DART AEROSPACE LTD •

This document is private and confidential and is supplied on the express condition that it is not to be used for any purpose or copied or communicated to any other person without written permission from Dart Aerospace Ltd.

Unapproved

Revision: **A**
Date: 07.06.01